

# MOMENTUM

BY GRAND DESIGN  
RECREATIONAL VEHICLES

*Absolute Luxury Toy Hauler*



Owner's Manual





Welcome to Our Family!

Thank you for purchasing a quality built Grand Design recreational vehicle and choosing the RV lifestyle as a family friendly form of leisure, recreation and fun. It is the intent of the Grand Design RV Team and our Dealer Partners to do our absolute best to assure that you enjoy a positive ownership experience and capitalize on all the exciting opportunities this "Grand" lifestyle has to offer.

Your new Grand Design RV has been designed & built to our personal high standards as well as those of the Recreational Vehicle Industry Association. In addition, our products meet or exceed all applicable state and federal regulations, standards & requirements in order to assure your safety.

Please thoroughly read and understand the content of this Owner's Manual and the various component manufacturer manuals that came with your RV. It is imperative for your personal safety that you become familiar with and learn how to properly operate the various systems, appliances and components included in your RV. Read all cautions, warnings and notices very carefully. Familiarize yourself and your family with the safety features built into your RV, and what actions and steps are necessary to assure safe camping. Always place the safety of you and your family first.

Please carefully read the Limited Base Warranty and Limited Structural Warranty that comes with your new RV. Be sure to understand the extent of your coverage and duration as well as the various exclusions and limitations that may apply. In addition, please understand the ongoing maintenance & upkeep requirements that need to be performed for your warranty to remain in effect. Failure to perform required maintenance could void your warranty. Your new RV may have additional warranties provided by the various component suppliers that extend beyond the Limited Base Warranty. Please be sure to read all component warranty information found in your Owner's Packet and submit any required registration forms.

Again, thank you from Grand Design RV & your Grand Design RV Dealer for your purchase. We wish you many safe and enjoyable journeys in your new RV and a lifetime of fond memories.

11333 County Road 2, Middlebury, IN 46540  
Phone: 574-825-8000, Fax: 574-825-9700  
[www.granddesignrv.com](http://www.granddesignrv.com)

This page is intentionally blank



## Table of Contents

<b>Section</b>	<b>Description</b>	<b>Page</b>
1	Introduction.....	1
2	Reporting Safety Defects .....	5
3	Service & Warranty.....	7
4	Component Manufacturer List .....	23
5	Occupant Safety.....	25
6	Pre-Travel Information .....	43
7	Towing & Leveling.....	57
8	Electrical Systems .....	67
9	Fuel System.....	81
10	Propane System.....	85
11	Plumbing Systems.....	93
12	Slideout Systems.....	109
13	Appliances .....	115
14	Cooling & Heating.....	119
15	Electronics .....	123
16	Garage .....	127
17	Interior.....	133
18	Exterior .....	137
19	Basic Troubleshooting .....	145
20	Glossary & Index.....	153

## Table of Contents

This page is intentionally blank

## **About This Manual**

The purpose of this manual is to serve as guide to describe normal operation, safety, care and maintenance of your recreation vehicle (RV). Information in this manual is subject to change without notice and represents information relevant at the time this version was published. The photographs, drawings, components and systems described may not represent what is actually in your RV due to ongoing upgrades and improvements. There is nothing in this manual that creates any warranty, express or implied. Information in this manual is not meant in any way to supplement, modify or alter the terms and conditions of your Limited Base and Structural Warranties or any component manufacturer warranties.

Procedures outlined in this guide are typical for normal operating conditions. You are responsible for the safe operation and use of your RV, and we have tried to include information to assist you. There are occasional tips to help you enjoy the recreational lifestyle; however, this guide is not intended to teach you how to camp, or where. If you ever have any questions, concerns or require assistance regarding any aspect of your RV, please contact your dealer or Grand Design RV. Our Customer Service contact information is:

### Mailing Address:

Grand Design RV  
Attn: Customer Service  
11333 County Road 2  
Middlebury IN 46540

### Shipping Address

Grand Design RV  
Attn: Customer Service  
11333 CR 2 Bldg 3 Door 10  
Middlebury IN 46540

Phone: (574) 825-8000

Fax: (574) 825-9700

Email: [customerservice@granddesignrv.com](mailto:customerservice@granddesignrv.com)

Website: [www.granddesignrv.com](http://www.granddesignrv.com)

## **Owner's Information Package**

Your new Momentum fifth wheel (FW) toy hauler includes an Owner's Information Package that contains various component manufacturer manuals and registrations. Some component manufacturers offer warranties beyond that offered through the Limited Base and Structural Warranties. Some components are excluded from the Limited Base and Structural Warranties, and are warranted separately and exclusively by the individual component manufacturer. Activation of each component warranty is critical, so it is important you register within the prescribed time limits to avoid loss of warranty coverage.

**It is important you read and understand the information in this manual and your Owner's Information Package before using your RV.**



*This manual and the Owner's Information Package should be considered a permanent part of the RV. If the RV is sold, they should remain with the RV for the next owner.*

## **Manufacturing Certification**



Grand Design RV recreation vehicles are subject to frequent and random audits to confirm our RV's are constructed to the thorough safety and manufacturing codes, standards and regulations established by the Recreation Vehicle Industry Association (RVIA) and Transport Canada (CSA).

Either a RVIA or CSA label is affixed to the sidewall next to the entry door to confirm your RV has been constructed to these exacting codes and standards. RV's built for sale in Canada may differ to conform to Canadian Codes.

## **The Vehicle Identification Number**

The 17-digit vehicle identification number (VIN) is listed on the Federal Certification label and is stamped on a permanently affixed metal tag attached to the pin box. A breakdown of a typical Grand Design RV VIN is shown in the example below:

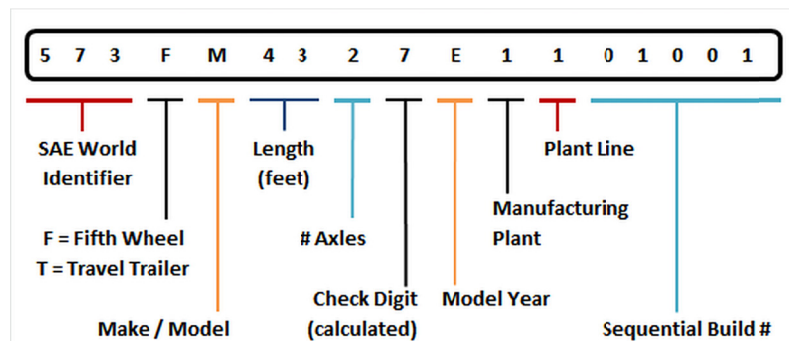

### SAE World Identifier:

573 - Grand Design RV

### Make / Model:

M – Momentum fifth wheel (FW)

### Length:

The number listed falls within a pre-determined, specified grouping that does not indicate the actual measured length of your RV.

### Model Year:

- E - 2014
- F - 2015
- G - 2016
- H - 2017
- I - 2018
- J - 2019



Your RV serial number is comprised of the last 8-digits of the VIN. In the example shown, the RV serial number is E1101001.



## **Safety Precautions**

Nothing is more important than the personal safety of you, your family and others. Safety encompasses several areas related to the RV experience. This includes driving/towing safety, occupant safety, operational safety, environmental safety, and more. Any time you are dealing with carbon monoxide producing appliances, propane gas, electricity and other hazards it is critical that safety become your number one priority in and around your recreational vehicle.

Safety alert symbols and messages are used throughout your vehicle and in this manual:



The Safety Alert Symbol is used to alert you to potential personal injury hazards. It is imperative that you read, understand and abide by these safety alerts and messages to avoid possible personal injury or death.



**DANGER** indicates a hazardous situation which, if not avoided, will result in death or serious injury.



**WARNING** indicates a hazardous situation which, if not avoided, could result in death or serious injury.



**CAUTION**, used with the safety alert symbol, indicates a hazardous situation which, if not avoided, could result in minor or moderate injury.



**NOTICE** is used to address practices not related to personal injury. This applies to hazardous situations involving property damage only.

Additional terminology and symbols used:



**NOTE** is used to identify special attention items, like useful tips, reminders or maintenance items.

**[Optional]** This denotes items that may be an option on all or particular models. Additionally, some optional items can only be included during the manufacturing phase and cannot be added at a later date. The inclusion of optional items does not imply or suggest the availability, application sustainability or inclusion for any specific unit.



*Various warning, caution and information labels are located throughout your recreational vehicle, attached to surfaces both inside and outside of the vehicle. These are permanent labels, and should not be removed or relocated for any reason.*

This page is intentionally blank

## **Reporting Safety Defects**

### *United States*

If you believe that your vehicle has a defect which could cause a crash or could cause injury or death, you should immediately inform the National Highway Traffic Safety Administration (NHTSA) in addition to notifying Grand Design RV. If NHTSA receives similar complaints, it may open an investigation, and if it finds that a safety defect exists in a group of vehicles, it may order a recall and remedy campaign. However, NHTSA cannot become involved in individual problems between you, your dealer or Grand Design RV.

To contact NHTSA, you may either call the Vehicle Safety Hotline toll-free at 1-888-327-4236 (TTY: 1-800-424-9153); go to <http://www.safercar.gov>; or write to: Administrator, NHTSA, 1200 New Jersey Avenue, S.E., Washington, DC 20590. You can also obtain other information about motor vehicle safety from <http://www.safercar.gov>.

### *Canada*

If you believe that your vehicle has a defect which could cause a crash or could cause injury or death, you should immediately contact the Motor Vehicle Safety Enforcement Division of Transport Canada and Grand Design RV.

To contact Transport Canada, call the Road Safety and Motor Vehicle Regulation Directorate at 1-800-333-0510 (or 1-613-993-3640 if calling from the Ottawa Region); go to [www.tc.gc.ca](http://www.tc.gc.ca); or write to: Motor Vehicle Safety Enforcement, Transport Canada, 330 Sparks Street, Ottawa, Ontario K1A 0N5.

This page is intentionally blank

## **Service & Warranty**

### **Dealer's Responsibilities**

At the time of sale of the new RV, your dealer is expected to:

1. Deliver your RV in the best condition possible. Your RV must pass the dealer's Pre-Delivery Inspection (PDI), which includes all system tests.
2. Provide orientation and familiarize the customer with the operation of all systems and components of the new RV.
3. Explain and review the provisions of the Limited Base Warranty and Limited Structural Warranty to the customer.
4. Ensure the customer receives a complete Owner Information Package. Assist the customer in completing all necessary warranty registrations, including locating model and serial numbers as needed.
5. Instruct the customer on how to receive local and out of town service on the RV and its separately warranted components, whether in or out of warranty.
6. Service all Grand Design RV products.
7. Complete and return the "Warranty Registration and New Vehicle Pre-Delivery Inspection Check List" form within thirty (30) days from the date of delivery to Grand Design RV to activate your applicable warranty coverage.

### **Owner's Responsibilities**

As the owner, you are responsible for the regular care and proper maintenance of your RV. Proper maintenance will help avoid situations where the Limited Base Warranty and Limited Structural Warranty will not cover items due to neglect. You need to perform maintenance services in accordance with this manual and the corresponding manufacturer instructions for the components included in your RV.

As the owner, it is your responsibility and obligation to return the RV to an authorized dealer for any warranty repairs and service that may be required. Your dealer is responsible for proper service prior to delivery, and has a continued interest in your satisfaction. Therefore, we recommend warranty and maintenance services be performed by your Grand Design RV dealer.

As with your other personal belongings, it is important to protect yourself and others with insurance coverage. Your insurance agent can assist you in obtaining the appropriate insurance coverage for personal liability, theft, collision, property damage, etc.



*The Limited Base Warranty and Limited Structural Warranty are activated only after Grand Design RV receives the completed (signed and dated) warranty registration from your dealer.*

### **Obtaining Warranty Service**

Service must be obtained within a reasonable time after discovery of the defect and prior to the applicable warranty expiration period. To help ensure your dealer provides the level of service you expect, here are some suggestions:

**Call ahead...** Do not wait until you are ready to use your RV, as your dealer may not be able to schedule it in immediately. Generally, the service department is busiest on Mondays, Fridays and before the holidays.

**Be prepared...** Have your warranty paperwork available, and provide the service center with any past repair history as it may assist the dealer technician in diagnosing the current issue.

**Make a list...** Provide a written list of repairs needed in specific order of priority, and be reasonable with repair expectations. If you need your RV returned by a specific time, discuss the situation with the dealer's service management as a second appointment may be necessary for work not completed or parts that may need ordered.

**While waiting...** Drop your RV off if possible. Do not be surprised if told you cannot watch work being done. Some insurance requirements forbid admission of customers to the service area.

**Inspect the work performed...** After a repair is performed inspect it thoroughly. Notify the dealer's service management immediately of any dissatisfaction. If you cannot return your RV immediately for repair, make an appointment as soon as possible. In the event the issue should re-occur after you have left the dealership, contact the repair center and Grand Design RV Customer Service as soon as possible, so the situation can be resolved expediently.

### **Obtaining Emergency Warranty Repair**

A roadside emergency can happen at any time, whether your RV is new or old. If you are traveling, using the following guidelines can help get you back on the road faster.

1. Use the "Dealer Locator" on our website to locate the nearest authorized repair center.
2. If you cannot locate an authorized dealer near you, ask the campground staff for referrals or check the local telephone yellow pages. Or contact Grand Design RV Customer Service or your selling dealer for assistance in locating a repair facility.



*Please be aware that all repair businesses require notification of any issues with their repairs within a specified time limit. Make sure you are familiar with your dealer or RV repair center's repair policies.*

- a. Contact the RV repair facility to discuss your situation and make an appointment. Ask how their billing will be handled. They may choose to bill Grand Design RV directly; otherwise, you are expected to pay them.
- b. Have the RV repair facility inspect your RV. Either they or you must call Grand Design RV Customer Service to discuss applicable warranty coverage prior to any repair work being performed.
- c. Grand Design RV Customer Service will issue an authorization number upon warranty repair approval and advise if any original parts must be returned.
- d. After the authorization number has been issued, the repair center may begin actual repair on your RV.
- e. Inspect the completed repair work thoroughly. If you are not satisfied, communicate that to the RV repair facility management. Make sure you are satisfied with the repair before you pay or leave the premises.
- f. For reimbursement, either you or the RV repair facility must send a copy of your itemized repair bill and all requested return parts by UPS (regular ground, freight pre-paid) to Grand Design RV within 60-days of the completed repair date. To expedite processing your warranty claim, include your name, address, phone number, RV 17-digit VIN and authorization number. If returning parts, include a copy of your freight bill.

*Obtaining weekend or after business hours emergency repair assistance*

If an authorized Grand Design RV dealer is not located nearby, contact your selling dealer for assistance. If your dealer is closed, check with the campground staff or telephone yellow pages for an RV repair facility. Have the item repaired and contact Grand Design RV Customer Service immediately the following business day.

*An important note about alterations and warranties*

Installations or alterations to the original equipment vehicle as distributed by Grand Design RV are not covered by the Limited Base and Structural Warranties. The special body company, assembler, equipment installer or upfitter is solely responsible for warranties on the body or equipment and any alterations (or any effect of the alterations) to any of the parts, components, systems or assemblies installed by Grand Design RV. Grand Design RV is not responsible for the safety or quality of design features, materials or workmanship of any alterations by such suppliers.



*Please have the following available when you call:*

- *Your name, location and a phone number where you can be reached*
- *Your RV 17-digit VIN*
- *Date of purchase*
- *Contact information for the RV repair facility or dealer*
- *Detailed description of the concern*
- *If applicable, the component description, serial and model numbers*



*Failure to contact Grand Design RV Customer Service, unauthorized or improper warranty repairs, or failure to return requested original parts may result in loss of reimbursement and/or loss of warranty.*

**Replacement Parts**

Replacement warranty parts are distributed exclusively by authorized Grand Design RV dealers or service centers. Grand Design RV does not sell parts retail direct or to non-authorized dealers. If an original part is no longer available, Grand Design RV or your dealer will try to provide an appropriate substitute.

**Updating Your Contact Information**

Federal record keeping laws require that we maintain a file of owners of our RVs. Please help us keep your contact information updated so that, in the event of a recall or customer notification letter, you are notified. Please let us know (in writing) in the event of a change of address or ownership, or if your RV is stolen, totaled or destroyed.



## **Grand Design RV, LLC ONE YEAR LIMITED BASE WARRANTY**

### **SUMMARY**

#### **What does this Warranty cover?**

Grand Design RV, LLC (“Warrantor”) provides this One (1) Year (“Warranty Period”) Limited Base Warranty [which begins to run from the earlier of (i) the date of purchase by the original retail consumer purchaser or (ii) when the recreational vehicle is put into service] against certain defects in materials and/or workmanship for the recreational vehicle manufactured by, and workmanship provided directly by, Warrantor arising under normal use and service to the ORIGINAL RETAIL CONSUMER PURCHASER for the Warranty Period of the recreational vehicle. This Warranty only covers material components and parts of the recreational vehicle actually manufactured by and made by Warrantor and labor provided directly by Warrantor but no parts not made or manufactured by Warrantor. In addition to the forgoing and the other limitations and restrictions set for in this limited warranty, this limited warranty only covers a recreational vehicle sold by an authorized warrantor dealer to the original retail customer or its assign (transfer) to another retail purchaser within the warranty period, but only if the warranty for the recreational vehicle is registered in the original vehicle owner’s name within the thirty (30) day start date period set forth above.

THIS WARRANTY CONSTITUTES THE EXCLUSIVE REMEDY FOR ALL DEFECTS OF MATERIAL AND WORKMANSHIP. THIS WARRANTY IS IN LIEU OF ANY AND ALL OTHER EXPRESSED OR IMPLIED WARRANTIES. THERE ARE NO OTHER EXPRESSED OR IMPLIED WARRANTIES BEYOND THOSE SET FORTH HEREIN. THERE ARE NO WARRANTIES WHICH EXTEND BEYOND THE DESCRIPTION ON THE FACE HEREOF. IN ADDITION TO THE EXCLUSIONS SET FORTH IN THIS LIMITED WARRANTY, THIS WARRANTY DOES NOT APPLY TO DAMAGE DUE TO NEGLIGENT USE, MISUSE, ABUSE OR ACCIDENT INVOLVING ANY PART AND/OR ALL OF THE RECREATIONAL VEHICLE, OR THE REPAIR OR ALTERATION OF SUCH RECREATIONAL VEHICLE. ANY REPAIR OR ALTERATION TO THE RECREATIONAL VEHICLE SPECIFICALLY VOIDS THIS WARRANTY. ANY COMMERCIAL USE, RENTAL, OR BUSINESS USE OF THE RECREATIONAL VEHICLE VOIDS THIS AND ALL OTHER WARRANTIES PROVIDED BY WARRANTOR.

The sole remedy for a breach of the warranty is as follows. Defective parts and workmanship will be replaced by the Warrantor, or the Warrantor’s authorized agent, provided that the following terms are met:

1. The Warrantor’s authorized agent must be notified of the covered defect within the warranty period and within Twenty (20) days of when the defect was discovered or should have been discovered by a reasonable person exercising reasonable care according to the terms of this Limited Warranty.
2. The person seeking the replacement of the defective part or labor must be the original retail consumer purchaser, or an assignment to another consumer purchaser within the Warranty Period. Any assignment does not extend the Warrant Period.

## Service & Warranty

3. The defective material or workmanship for which the warranty work and/or part is sought must be to the RECREATIONAL VEHICLE itself only.
4. The other terms and conditions of this Limited Warranty must be satisfied.

### **What types of things are excluded from the Warranty?**

This Warranty does not cover:

- a. Defects in any component parts or labor of the recreational vehicle which are not considered the RECREATIONAL VEHICLE or which were not manufactured by Warrantor;
- b. Defects in any items or labor which are covered by a separate warranty from the original manufacturer of any part that is used by Warrantor in the RECREATIONAL VEHICLE;
- c. Deterioration due to normal wear, tear, and exposure;
- d. Repairs or replacements made necessary by negligence, negligent use of, misuse of, abuse of, loading the unit beyond its gross weight limitations, accidents, acts of God, modifications or alterations in or to the RECREATIONAL VEHICLE by anyone, and failure to maintain or care for the RECREATIONAL VEHICLE, and any and all matters which were not within the control of the Warrantor;
- e. Neglect of the recreational vehicle or any part of it;
- f. Repairs or replacements made necessary by reason of a failure of the original retail consumer purchaser or others to follow ordinary maintenance procedures as recommended by the Warrantor or the manufacturer or dealer of the recreational vehicle;
- g. Any defect caused in-transit to or from a dealer or to or from the consumer or by the consumer or another;
- h. Any defects in work, labor, materials or parts not actually manufactured by, performed by or made by Warrantor;
- i. Tires; Batteries; Optional Generators and certain Appliances & Electronic Entertainment Equipment which is warranted separately by the respective component manufacturer.
- j. Recreational vehicles purchased anywhere other than from an authorized Warrantor dealer;
- k. Alterations, modifications or changes to the original design and build of the recreational vehicle;
- l. Vehicles used for rental, business or disaster relief purposes;
- m. Routine maintenance and adjustments;
- n. Vehicles registered and used outside the U.S. and Canada;
- o. Consequential/incidental expenses (damages) such as service calls, transportation, lodging, food, fuel, etc. **NOTE: Some states do not allow the exclusion of incidental or consequential damages, so this exclusion may not apply to you;**
- p. Fading, yellowing or aging of exterior materials due to UV or sunlight or weather exposure;
- q. Damage that has occurred as a result of misuse, abuse, neglect, or lack of maintenance;
- r. Damage caused by unregulated water pressure, tank over-fill or plumbing system modifications resulting in flooding of the vehicle;

- s. Damage caused by unprotected electrical hook-ups (home or campground), power surges, lightning, circuit overload or electrical system modifications;
- t. Damage caused by overloading or improper weight distribution;
- u. Damage caused by improper ventilation resulting in excessive condensation which results in water damage and/or mold or mildew;
- v. Damage, fading or deterioration caused by prolonged exposure to natural elements;
- w. Damage caused by infestation by insects or other animals;
- x. Damage caused by the tow vehicle hitch, equalizer, stabilizer, electrical or brake controller system;
- y. Damage caused by the environment or weather, including, but not limited to, flooding, high winds, acid rain, hail, lightning, high heat, extreme cold, etc.
- z. Damage caused by road surface conditions, applications of salt or de-icing chemicals, gravel/sand, ruts, holes, etc.;
- aa. Exterior paint or finish which is warranted independently by the paint manufacturer and/or independent applicator;
- bb. DEFACING: scratches, dents, and rust on any surface of the RECREATIONAL VEHICLE; and
- cc. EXCESS weight on the RECREATIONAL VEHICLE.

## **WARRANTOR'S OBLIGATIONS - HOW TO GET WARRANTY SERVICES**

### **How Do You Get Service?**

In no event shall repair or replacement for a defect be covered under this Warranty unless the repair or replacement occurs at Warrantor's facilities, or Warrantor's designated repair shop or dealer. Upon discovery of any defect covered by this Warranty, you must notify the authorized dealer from whom you purchased the recreational vehicle. Following notification, the recreational vehicle must be taken to the authorized dealer from whom you purchased it for inspection or another authorized dealer, if authorized by Warrantor, or authorized repair shop as directed by Warrantor. Either that dealer or repair shop or Warrantor will undertake appropriate corrective repairs in instances where the defect is covered by this Warranty. Warrantor reserves the right to use or cause the use of alternative parts or components having substantially equal or greater quality.

Warrantor will remedy defects in materials and workmanship covered under this Limited Warranty under normal use and service caused by Warrantor in the RECREATIONAL VEHICLE ONLY of the recreational vehicle. Warranty performance can only be obtained at Warrantor's authorized dealers and service representatives. All costs incurred in transporting this recreational vehicle for warranty service shall be borne by purchaser unless otherwise approved in advance by Warrantor.

### **What are purchaser's obligations?**

The purchaser shall give notice to the Warrantor's agent or dealer within Twenty (20) days after it is or should have been discovered, and any action to enforce it shall be commenced not more than three (3) months thereafter; otherwise the Purchaser will have waived any such defect and claim, and any and all damages arising as a result thereof. The purchaser must perform reasonable and necessary maintenance upon the recreational vehicle and use the recreational vehicle in accordance with the manufacturer of the recreational vehicle's and Warrantor's directions and recommendations. Among the other requirements under this Warranty, the Purchaser must also:

## Service & Warranty

- Maintain the recreational vehicle in accordance with the maintenance requirements contained in the Owner's Manual;
- Make minor adjustments including (but limited to) doors, drawers, latches, regulators, controls, mechanisms, etc. after 90 days of ownership;
- Maintain all exterior seals and sealant, which must be inspected every 6 months to assure there are no gaps or voids, and correcting as necessary; and
- Return their vehicle to an authorized dealer for repairs.

If you believe that you have a claim under this Warranty, locate and contact your nearest authorized Warrantor dealer to schedule an appointment. Be prepared to provide your vehicle serial number (VIN), date of purchase, and a description of the issue or concern. If you cannot locate a dealer, please go to the Warrantor's web site or contact Warrantor directly for immediate assistance.

### **What are the Dealer's Responsibilities?**

- Perform a walk-through to assure that the customer understands the operation, use and safety requirements of the vehicle;
- Review vehicle warranties, operating manuals and instruction guides; and
- Inform the customer on how to obtain service, locally or while in transit;

**Warrantor is not responsible or liable for any failures, breaches, negligence, inattention or problems on the part of the Dealer.**

### **What events discharge Warrantor from the obligations under this Warranty?**

**Misuse or negligent use, abuse, or accident, neglect, unauthorized alteration, failure to provide reasonable and necessary maintenance including reasonable periodic inspections of the recreational vehicle and/or use of the recreational vehicle for rental, business or commercial use or any other use other than to use the recreational vehicle only for personal and occasional use, shall each discharge the Warrantor from any obligation under this Warranty. The recreational vehicle is designed for recreational and personal use.**

**What do I do to activate warranties of other manufacturers of component parts and goods?**

### **COMPONENT WARRANTIES**

**As stated above, some components, accessories or equipment are not covered by this Base Limited Warranty. Examples include tires, batteries, optional generators, and some appliance & electronic entertainment equipment. However, those items may have coverage provided by the component manufacturer. These warranties are completely separate from this Limited Base Warranty, and in some cases may be longer and/or have specific coverage provisions and requirements. In order to activate these warranties you may have to complete registration forms, post cards or some other form of notification to the component manufacturer within a specific time period. These forms and documents will be located with the Owner's Materials provided with your new vehicle. You must complete**

and submit them to the respective manufacturer as quickly as possible, and within the time periods required by those warranties.

**DISCLAIMER OF CONSEQUENTIAL, PUNITIVE AND INCIDENTAL DAMAGES**

What other conditions or limitations apply to this Warranty?

**The original retail purchaser of the recreational vehicle and any person to whom the recreational vehicle is transferred or given or conveyed, and any person who is an intended or unintended user or beneficiary of this Limited Warranty, shall not be entitled to recover from Warrantor any consequential, punitive or incidental damages resulting from any defect in the recreational vehicle, or loss of use, time or revenues.** This warranty also excludes costs of transportation to any authorized dealer or service representative or to the Warrantor to get warranty service, loss of use of the recreational vehicle, loss of time, loss of revenues, inconvenience, or other incidental or consequential damage and any punitive damages, with respect to business or property, whether as a result of breach of warranty, negligence, or otherwise.

Some states do not allow the exclusion or limitation or the exclusion may not apply to you.

**TO THE EXTENT NOT EXCLUDED IN THIS LIMITED WARRANTY, THE IMPLIED WARRANTY OF MERCHANTABILITY, AN UNWRITTEN WARRANTY THAT THE PRODUCT IS FIT FOR ORDINARY USE, IS LIMITED TO THE WARRANTY PERIOD OF THIS WRITTEN WARRANTY, AND ANY OTHER IMPLIED WARRANTY ARISING BY OPERATION OF LAW ARE SPECIFICALLY LIMITED TO THE WARRANTY PERIOD OF THIS WRITTEN WARRANTY TO THE EXTENT NOT ACTUALLY EXCLUDED IN THIS LIMITED WARRANTY.**

**IF ANY MODEL OR SAMPLE IS SHOWN TO THE PURCHASER PRIOR TO THE PURCHASE OF THE RECREATIONAL VEHICLE, SUCH SAMPLE OR MODEL WAS MERELY TO ILLUSTRATE A GENERAL TYPE OF QUALITY AND NOT TO REPRESENT THAT THE RECREATIONAL VEHICLE WOULD NECESSARILY CONFORM TO A SAMPLE OR MODEL AND SHALL NOT BE DEEMED TO BE PART OF THE BASIS OF THE BARGAIN OR CREATE ANY EXPRESSED WARRANTIES OR AFFIRMATIONS OR PROMISES.**

**DISCLAIMER OF EXPRESSED AND IMPLIED WARRANTIES**

**THE WARRANTOR EXPRESSLY DISCLAIMS ALL IMPLIED WARRANTIES OF MERCHANTABILITY AND FITNESS FOR A PARTICULAR PURPOSE AND ANY OTHER IMPLIED WARRANTIES.**

**THERE IS NO EXPRESS OR IMPLIED WARRANTY MADE BY WARRANTOR BEYOND THAT CONTAINED IN THE LIMITED WARRANTY ABOVE. THE ABOVE REFERENCED LIMITED WARRANTY IS IN LIEU OF ANY AND ALL OTHER WARRANTIES. TO ACTIVATE THE LIMITED WARRANTY, THE RECREATIONAL VEHICLE MUST BE REGISTERED WITHIN THIRTY (30) DAYS OF THE DATE OF**

## Service & Warranty

**PURCHASE; OTHERWISE, THIS LIMITED WARRANTY WILL NOT BE EFFECTIVE. NO PERSON HAS THE AUTHORITY TO ENLARGE, AMEND, OR MODIFY THIS WARRANTY.**

**Some states do not allow limitations on how long an implied warranty lasts, so the above limitations may not apply to you.**

### **DESIGN CHANGES**

Warrantor reserves the right to change the design of its RECREATIONAL VEHICLE from time to time without notice and without obligation to make corresponding changes in its products previously manufactured.

### **ATTORNEYS FEES**

Any warranty claim asserted or brought in violation of this Limited Warranty, or any claim brought against WARRANTOR, directly or indirectly, under which the Purchaser or any other person or entity seeks to broaden the terms of the Limited Warranty or under which the Purchaser or any other person fails to successfully prevail on any issue or matter of any type or nature, shall entitle Warrantor to recover its costs, damages, and reasonable attorney's fees in connection with the same.

### **How Does State Law Relate to This Warranty?**

This Warranty gives you specific legal rights, and you may also have other rights which vary from state to state.

**By registering or having your recreational vehicle registered in your name, or by asserting a claim under this Limited Warranty, Purchaser (and all assigns) is agreeing on behalf of the purchaser and all assigns to be bound by the terms and conditions of this Limited Warranty.**

## **Grand Design RV, LLC**

### **THREE YEAR LIMITED STRUCTURAL WARRANTY**

#### **SUMMARY**

##### **What does this Warranty cover?**

Grand Design RV, LLC (“Warrantor”) provides this Three (3) Year (“Warranty Period”) Limited Structural Warranty [which begins to run from the earlier of (i) the date of purchase by the original retail consumer purchaser or (ii) when the recreational vehicle is put into service] against certain defects in materials and/or workmanship for the structural components manufactured by, and workmanship provided directly by, Warrantor arising under normal use and service to **the structural components (as defined below) for the above described recreational vehicle** of Warrantors to the ORIGINAL RETAIL CONSUMER PURCHASER for the Warranty Period. This Warranty only covers material components and parts of the Structural Components actually manufactured by and made by Warrantor and labor provided directly by Warrantor. In addition to the forgoing and the other limitations and restrictions set for in this limited warranty, this limited warranty only covers a recreational vehicle sold to the original retail customer by an authorized warrantor dealer within the thirty (30) day start period set forth above. This Warranty is not assignable to any person or entity.

**“Structural Components” consist of:** materials and/or workmanship directly attributable to Warrantor, namely, the laminated fiberglass sidewall assembly, laminated fiberglass rear wall assembly, laminated fiberglass front wall (wrap) assembly, sidewall/end wall/front and rear wall frame assembly (wood and aluminum), roof assembly, and floor assembly.

THIS WARRANTY CONSTITUTES THE EXCLUSIVE REMEDY FOR ALL DEFECTS OF MATERIAL AND WORKMANSHIP. THIS WARRANTY IS IN LIEU OF ANY AND ALL OTHER EXPRESSED OR IMPLIED WARRANTIES. THERE ARE NO OTHER EXPRESSED OR IMPLIED WARRANTIES BEYOND THOSE SET FORTH HEREIN. THERE ARE NO WARRANTIES WHICH EXTEND BEYOND THE DESCRIPTION ON THE FACE HEREOF. IN ADDITION TO THE EXCLUSIONS SET FORTH IN THIS LIMITED WARRANTY, THIS WARRANTY DOES NOT APPLY TO DAMAGE DUE TO NEGLIGENT USE, MISUSE, ABUSE OR ACCIDENT INVOLVING ANY PART AND/OR ALL OF THE STRUCTURAL COMPONENTS, OR THE REPAIR OR ALTERATION OF SUCH STRUCTURAL COMPONENTS. ANY REPAIR OR ALTERATION TO THE STRUCTURAL COMPONENTS SPECIFICALLY VOIDS THIS WARRANTY. ANY COMMERCIAL USE, RENTAL, OR BUSINESS USE OF THE RECREATIONAL VEHICLE VOIDS THIS AND ALL OTHER WARRANTIES PROVIDED BY WARRANTOR.

The sole remedy for a breach of the warranty is as follows. Defective parts and workmanship will be replaced by the Warrantor, or the Warrantor’s authorized agent, provided that the following terms are met:

1. The Warrantor’s authorized agent must be notified of the covered defect within the warranty period and within Twenty (20) days of when the defect was discovered or should have been discovered by a reasonable person exercising reasonable care according to the terms of this Limited Warranty.

## Service & Warranty

2. The person seeking the replacement of the defective part or labor must be the original retail consumer purchaser. An assignment of the recreational vehicle to another person voids this Limited Warranty.
3. The defective material or workmanship for which the warranty work and/or part is sought must be to the STRUCTURAL COMPONENTS only.
4. The other terms and conditions of this Limited Warranty must be satisfied.

### **What types of things are excluded from the Warranty?**

This Warranty does not cover:

- a. Defects in any component parts or labor of the recreational vehicle which are not considered the STRUCTURAL COMPONENTS or which were not manufactured by Warrantor;
- b. Defects in any items or labor which are covered by a separate warranty from the original manufacturer of any part that is used by Warrantor in the STRUCTURAL COMPONENTS;
- c. Deterioration due to normal wear, tear, and exposure;
- d. Repairs or replacements made necessary by negligence, negligent use of, misuse of, abuse of, loading the unit beyond its gross weight limitations, accidents, acts of God, modifications or alterations in or to the STRUCTURAL COMPONENTS by anyone, and failure to maintain or care for the STRUCTURAL COMPONENTS, and any and all matters which were not within the control of the Warrantor;
- e. Neglect of the recreational vehicle or STRUCTURAL COMPONENTS;
- f. Repairs or replacements made necessary by reason of a failure of the original retail consumer purchaser or others to follow ordinary maintenance procedures as recommended by the Warrantor or the manufacturer or dealer of the Structural Components;
- g. Any defect caused in-transit to or from a dealer or to or from the consumer or by the consumer or another;
- h. Any defects in work, labor, materials or parts not actually manufactured by, performed by or made by Warrantor;
- i. Front and rear fiberglass caps and any other cosmetic fiberglass attachments;
- j. Sidewall metal (unless the root cause is the wall structure);
- k. Exterior roof material (EPDM rubber, TPO, etc.);
- l. Floor covering (carpet, linoleum, hardwood, tile, etc.);
- m. All sidewall, end wall, front and rear wall, roof and floor attachments;
- n. Delamination caused by water intrusion from lack of required exterior seal maintenance;
- o. Vehicles purchased anywhere other than from an authorized Warrantor dealer;
- p. Alterations, modifications or changes to the original design and build of the recreational vehicle;
- q. Vehicles used for rental, business or disaster relief purposes;
- r. Routine maintenance and adjustments;
- s. Vehicles registered and used outside the U.S. and Canada;
- t. Consequential/incidental expenses (damages) such as service calls, transportation, lodging, food, fuel, etc. **NOTE: Some states do not allow the exclusion of incidental or consequential damages, so this exclusion may not apply to you;**



- u. Fading, yellowing or aging of exterior materials due to UV or sunlight or weather exposure;
- v. Damage that has occurred as a result of misuse, abuse, neglect, or lack of maintenance;
- w. Damage caused by unregulated water pressure, tank over-fill or plumbing system modifications resulting in flooding of the vehicle;
- x. Damage caused by unprotected electrical hook-ups (home or campground), power surges, lightning, circuit overload or electrical system modifications;
- y. Damage caused by overloading or improper weight distribution;
- z. Damage caused by improper ventilation resulting in excessive condensation which results in water damage and/or mold or mildew;
- aa. Damage, fading or deterioration caused by prolonged exposure to natural elements;
- bb. Damage caused by infestation by insects or other animals;
- cc. Damage caused by the tow vehicle hitch, equalizer, stabilizer, electrical or brake controller system;
- dd. Damage caused by the environment or weather, including, but not limited to, flooding, high winds, acid rain, hail, lightning, high heat, extreme cold, etc.
- ee. Damage caused by road surface conditions, applications of salt or de-icing chemicals, gravel/sand, ruts, holes, etc.;
- ff. Exterior paint or finish which is warranted independently by the paint manufacturer and/or independent applicator;
- gg. DEFACING: scratches, dents, and rust on any surface of the STRUCTURAL COMPONENTS; and
- hh. EXCESS weight on the STRUCTURAL COMPONENTS.

## **WARRANTOR'S OBLIGATIONS - HOW TO GET WARRANTY SERVICES**

### **How Do You Get Service?**

In no event shall repair or replacement for a defect be covered under this Warranty unless the repair or replacement occurs at Warrantor's facilities, or Warrantor's designated repair shop or dealer. Upon discovery of any defect covered by this Warranty, you must notify the authorized dealer from whom you purchased the recreational vehicle Warrantor. You must always notify the Warrantor as well even if you contact the dealer from whom you purchased the recreational vehicle. Following notification, the recreational vehicle must be taken to the authorized dealer from whom you purchased it for inspection or another authorized dealer, if authorized by Warrantor, or authorized repair shop as directed by Warrantor. Either that dealer or repair shop or Warrantor will undertake appropriate corrective repairs in instances where the defect is covered by this Warranty. However, no work may be performed to the STRUCTURAL COMPONENTS without the prior authorization of the Warrantor. And, Warrantor reserves the right to use or cause the use of alternative parts or components having substantially equal or greater quality.

Warrantor will remedy defects in materials and workmanship covered under this Limited Warranty under normal use and service caused by Warrantor in the STRUCTURAL COMPONENTS ONLY of the recreational vehicle. Warranty performance can only be obtained at Warrantor's authorized dealers and service representatives. All costs incurred in transporting this recreational vehicle for warranty service shall be borne by purchaser unless otherwise approved in advance by Warrantor.

## Service & Warranty

### **What are purchaser's obligations?**

The purchaser shall give written notice to the Warrantor or an Authorized Dealer of any defect within Twenty (20) days after it is or should have been discovered, and any action to enforce it shall be commenced not more than three (3) months thereafter; otherwise the Purchaser will have waived any such defect and claim, and any and all damages arising as a result thereof. The purchaser must perform reasonable and necessary maintenance upon the recreational vehicle and STRUCTURAL COMPONENTS and use the recreational vehicle and STRUCTURAL COMPONENTS in accordance with the manufacturer of the recreational vehicle's and Warrantor's directions and recommendations. Among the other requirements under this Warranty, the Purchaser must also:

- Maintain the recreational vehicle in accordance with the maintenance requirements contained in the Owner's Manual; and
- Maintain all exterior seals and sealant, which must be inspected every six (6) months by an authorized dealer or authorized repair shop to assure there are no gaps or voids, and all gaps and voids must be corrected as necessary. Documentation acceptable to Warrantor must be presented confirming completion of an annual sealant inspection by an authorized Warrantor dealer or authorized dealer repair shop for coverage consideration.

If you believe that you have a claim under this Warranty, locate and contact your nearest authorized Warrantor dealer to schedule an appointment. Be prepared to provide your vehicle serial number (VIN), date of purchase, and a description of the issue or concern. If you cannot locate a dealer, please go to the Warrantor's web site or contact Warrantor directly for immediate assistance.

### **What events discharge Warrantor from the obligations under this Warranty?**

**Misuse or negligent use, abuse, or accident, neglect, unauthorized alteration, failure to provide reasonable and necessary maintenance including reasonable periodic inspections of the recreational vehicle and STRUCTURAL COMPONENTS and/or use of the recreational vehicle for rental, business or commercial use or any other use other than to use the recreational vehicle only for personal and occasional use, and not for continual or permanent occupancy, shall each discharge the Warrantor from any obligation under this Warranty. The Structural Components in the recreational vehicle is designed for recreational and personal use.**

### **DISCLAIMER OF CONSEQUENTIAL, PUNITIVE AND INCIDENTAL DAMAGES**

#### **What other conditions or limitations apply to this Warranty?**

**The original retail purchaser of the recreational vehicle and any person to whom the recreational vehicle is transferred or given or conveyed, and any person who is an intended or unintended user or beneficiary of this Limited Warranty, shall not be entitled to recover from Warrantor any consequential, punitive or incidental damages resulting from any defect in the recreational vehicle, or loss of use, time or revenues. This warranty also excludes costs of**

transportation to any authorized dealer or service representative or to the Warrantor to get warranty service, loss of use of the recreational vehicle, loss of time, loss of revenues, inconvenience, or other incidental or consequential damage and any punitive damages, with respect to business or property, whether as a result of breach of warranty, negligence, or otherwise.

Some states do not allow the exclusion or limitation or the exclusion may not apply to you.

**TO THE EXTENT NOT EXCLUDED IN THIS LIMITED WARRANTY, THE IMPLIED WARRANTY OF MERCHANTABILITY, AN UNWRITTEN WARRANTY THAT THE PRODUCT IS FIT FOR ORDINARY USE, IS LIMITED TO THE WARRANTY PERIOD OF THIS WRITTEN WARRANTY, AND ANY OTHER IMPLIED WARRANTY ARISING BY OPERATION OF LAW ARE SPECIFICALLY LIMITED TO THE WARRANTY PERIOD OF THIS WRITTEN WARRANTY TO THE EXTENT NOT ACTUALLY EXCLUDED IN THIS LIMITED WARRANTY.**

**IF ANY MODEL OR SAMPLE IS SHOWN TO THE PURCHASER PRIOR TO THE PURCHASE OF THE RECREATIONAL VEHICLE/STRUCTURAL COMPONENTS, SUCH SAMPLE OR MODEL WAS MERELY TO ILLUSTRATE A GENERAL TYPE OF QUALITY AND NOT TO REPRESENT THAT THE RECREATIONAL VEHICLE/STRUCTURAL COMPONENTS WOULD NECESSARILY CONFORM TO A SAMPLE OR MODEL AND SHALL NOT BE DEEMED TO BE PART OF THE BASIS OF THE BARGAIN OR CREATE ANY EXPRESSED WARRANTIES OR AFFIRMATIONS OR PROMISES.**

#### **DISCLAIMER OF EXPRESSED AND IMPLIED WARRANTIES**

**THE WARRANTOR EXPRESSLY DISCLAIMS ALL IMPLIED WARRANTIES OF MERCHANTABILITY AND FITNESS FOR A PARTICULAR PURPOSE AND ANY OTHER IMPLIED WARRANTIES.**

**THERE IS NO EXPRESS OR IMPLIED WARRANTY MADE BY WARRANTOR BEYOND THAT CONTAINED IN THE LIMITED WARRANTY ABOVE. THE ABOVE REFERENCED LIMITED WARRANTY IS IN LIEU OF ANY AND ALL OTHER WARRANTIES. TO ACTIVATE THE LIMITED WARRANTY, YOU MUST RETURN THE ATTACHED NOTICE TO WARRANTOR WITHIN THIRTY (30) DAYS OF THE DATE OF PURCHASE; OTHERWISE, THIS LIMITED WARRANTY WILL NOT BE EFFECTIVE. NO PERSON HAS THE AUTHORITY TO ENLARGE, AMEND, OR MODIFY THIS WARRANTY.**

**Some states do not allow limitations on how long an implied warranty lasts, so the above limitations may not apply to you.**

#### **DESIGN CHANGES**

Warrantor reserves the right to change the design of its STRUCTURAL COMPONENTS from time to time without notice and without obligation to make corresponding changes in its products previously manufactured.

## Service & Warranty

### **ATTORNEYS FEES**

Any warranty claim asserted or brought in violation of this Limited Warranty, or any claim brought against WARRANTOR, directly or indirectly, under which the Purchaser or any other person or entity seeks to broaden the terms of the Limited Warranty or under which the Purchaser or any other person fails to successfully prevail on any issue or matter of any type or nature, shall entitle Warrantor to recover its costs, damages, and reasonable attorney's fees in connection with the same.

### **How Does State Law Relate to This Warranty?**

This Warranty gives you specific legal rights, and you may also have other rights which vary from state to state.

### **What to do if a separately manufactured part is defective?**

Our warranty does not cover defects in separately manufactured products which are not produced or manufactured directly by Warrantor. These products may be warranted by their individual manufacturers. To the extent that such products installed in your recreational vehicle or STRUCTURAL COMPONENTS are covered by warranties from those manufacturers, the written warranties by the suppliers of those products may be provided with each new recreational vehicle for the convenience and clarification of the original retail consumer purchaser. If you have trouble locating the manufacturer supplying these warranties, your dealer will be glad to assist you. However, we have no responsibility or control over the outcome of warranty claims against these manufacturers.

### **How Does State Law Relate to This Warranty?**

This Warranty gives you specific legal rights, and you may also have other rights which vary from state to state.

**By registering, or having your recreational vehicle registered in your name, or by asserting a claim under this Limited Warranty, Purchaser (and all assigns) is agreeing on behalf of Purchaser and all assigns to be bound by the terms and conditions of this Limited Warranty.**

<b>Momentum Component Manufacturer's Warranty Information</b>					
Component	Component Manufacturer	Component Manufacturer Website	Component Manufacturer Phone	Component Manufacturer Warranty Period	Grand Design Limited Warranty
Air Conditioner - Heat Pump	Dometic	<a href="http://www.dometicusa.com">www.dometicusa.com</a>	(800) 544-4881	2 Year	1 Year
Air Conditioner, roof mount 13.5 BTU	Dometic	<a href="http://www.dometicusa.com">www.dometicusa.com</a>	(800) 544-4881	2 Year	1 Year
Air Conditioner, roof mount 15.0 BTU	Dometic	<a href="http://www.dometicusa.com">www.dometicusa.com</a>	(800) 544-4881	2 Year	1 Year
Awning - Patio (main)	Carefree	<a href="http://www.carefreeofcolorado.com">www.carefreeofcolorado.com</a>	(800) 622-3230	1 Year	1 Year
Awning - Slide Topper	Carefree	<a href="http://www.carefreeofcolorado.com">www.carefreeofcolorado.com</a>	(800) 622-3230	1 Year	1 Year
Awning - Ramp Door Box	Carefree	<a href="http://www.carefreeofcolorado.com">www.carefreeofcolorado.com</a>	(800) 622-3230	1 Year	1 Year
Axle	Lippert Components	<a href="http://www.lci1.com">www.lci1.com</a>	(866) 524-7821	1 Year	1 Year
Back-Up Camera	Voyager (ASA)	<a href="http://www.asaelectronics.com">www.asaelectronics.com</a>	(877)305-0445	1 Year	1 Year
Baggage Doors	Challenger Door	<a href="http://www.challengerdoor.com">www.challengerdoor.com</a>	(574) 773-8148	2 Year	1 Year
Baggage Doors	Lippert Components	<a href="http://www.lci1.com">www.lci1.com</a>	(866) 524-7821	1 Year	1 Year
Bed Lift System	HappiJac	<a href="http://www.lci1.com">www.lci1.com</a>	(866) 524-7821	1 Year	1 Year
Carbon Monoxide / LP Alarm Combo	BRK Industries	<a href="http://www.brkelectronics.com">www.brkelectronics.com</a>	(800) 323-9005	10 Year	1 Year
Chairs - Dinette	Creative Wood	-	(260) 894-4533	1 Year	1 Year
Chairs - Recliners	Lippert/Seat Tech	<a href="http://www.lci1.com">www.lci1.com</a>	(866) 524-7821	1 Year	1 Year
Chairs - Swivel Rockers	Lippert/Seat Tech	<a href="http://www.lci1.com">www.lci1.com</a>	(866) 524-7821	1 Year	1 Year
Converter	WFCO (Cheng)	<a href="http://www.wfcoelectronics.com">www.wfcoelectronics.com</a>	(574) 294-8997	2 Year	1 Year
Countertops - Solid Surface	Patrick Ind. / Adorn	<a href="http://www.patrickind.com">www.patrickind.com</a>	(574) 294-7511	1 Year	1 Year
Entrance Door	Lippert Components	<a href="http://www.lci1.com">www.lci1.com</a>	(866) 524-7821	1 Year	1 Year
Entry Step	Lippert Components	<a href="http://www.lci1.com">www.lci1.com</a>	(866) 524-7821	1 Year	1 Year
Fiberglass Skin	Lami-Plast	-	(574) 264-1408	1 Year	1 Year
Fireplace, electric	Greystone	<a href="http://www.greystonehomecomfort.com">www.greystonehomecomfort.com</a>	(416) 783-7700	1 Year	1 Year
Flooring - carpet	Shaw Industries	<a href="http://www.shawfloors.com">www.shawfloors.com</a>	(800) 441-7429	1 Year	1 Year
Flooring - lino	Beauflor (Syntec)	<a href="http://www.syntecind.com">www.syntecind.com</a>	(800) 526-8428	7 Year	1 Year
Floors	Grand Design RV	<a href="http://www.granddesignrv.com">www.granddesignrv.com</a>	(574) 825-8000	3 Year	3 Year
Frame	Lippert Components	<a href="http://www.lci1.com">www.lci1.com</a>	(866) 524-7821	1 Year	1 Year
Front Cap	Global Composites	<a href="http://www.globalcompositesinc.com">www.globalcompositesinc.com</a>	(574) 522-9956	1 Year	1 Year
Fuel Control Panel	ECI Fuel Systems	<a href="http://www.ecifuel systems.com">www.ecifuel systems.com</a>	(877) 685-8602	1 year	1 Year
Fuel Pump	ECI Fuel Systems	<a href="http://www.ecifuel systems.com">www.ecifuel systems.com</a>	(877) 685-8602	2 Year	1 Year
Fuel Tanks	ECI Fuel Systems	<a href="http://www.ecifuel systems.com">www.ecifuel systems.com</a>	(877) 685-8602	3 Year	1 Year
Furnace	Suburban	<a href="http://www.rvcomfort.com">www.rvcomfort.com</a>	(423) 775-2131	2 Year	1 Year
Garage Pull-Down Screen	LaSalle-Bristol	<a href="http://www.lasallebristol.com">www.lasallebristol.com</a>	(800) 718-7187	1 year	1 Year
Generator	Onan	<a href="http://www.cumminsonan.com">www.cumminsonan.com</a>	(800) 888-6626	3 Year or 2000 hrs.	1 Year
Hydraulic Leveling System	Lippert Components	<a href="http://www.lci1.com">www.lci1.com</a>	(866) 524-7821	1 Year	1 Year
Load Center	WFCO (Cheng)	<a href="http://www.wfcoelectronics.com">www.wfcoelectronics.com</a>	(574) 294-8997	2 Year	1 Year
LP Bottles	Worthington	<a href="http://www.worthingtoncylinders.com">www.worthingtoncylinders.com</a>	(866) 928-2657	90 Days	1 Year
Mattress	Lippert Components	<a href="http://www.lci1.com">www.lci1.com</a>	(866) 524-7821	1 Year	1 Year
Microwave	Frigidaire	<a href="http://www.frigidare.com">www.frigidare.com</a>	(800) 944 9044	1 Year	1 Year
Monitor Panel	KIB Electronics	<a href="http://www.kibenterprises.com">www.kibenterprises.com</a>	(574) 262-0518	1 Year	1 Year
Pin Box	Lippert Components	<a href="http://www.lci1.com">www.lci1.com</a>	(866) 524-7821	1 Year	1 Year
Power Control System (EMS)	Precision Circuits	<a href="http://precisioncircuitsinc.com">precisioncircuitsinc.com</a>	630-515-9100	3 Year	1 Year
Ramp Door	Lippert Components	<a href="http://www.lci1.com">www.lci1.com</a>	(866) 524-7821	1 Year	1 Year
Ramp Door Patio System	Lippert Components	<a href="http://www.lci1.com">www.lci1.com</a>	(866) 524-7821	1 Year	1 Year
Range Top / Oven	Suburban	<a href="http://www.rvcomfort.com">www.rvcomfort.com</a>	(423) 775-2131	2 Year	1 Year
Refrigerator	Norcold	<a href="http://www.norcold.com">www.norcold.com</a>	(800) 543-1219	1 Year	1 Year
Roof	Grand Design RV	<a href="http://www.granddesignrv.com">www.granddesignrv.com</a>	(574) 825-8000	3 Year	3 Year
Roof Vent - Electric	Ventline	<a href="http://www.ventline.com">www.ventline.com</a>	(574) 848-4491	1 Year	1 Year
Roof Vent - Electric	MaxxFan	<a href="http://www.maxxair.com">www.maxxair.com</a>	(316) 832-3468	2 Years	1 Year
Roof Vent - manual	Ventline	<a href="http://www.ventline.com">www.ventline.com</a>	(574) 848-4491	1 Year	1 Year
Rubber Roof	Dicor	<a href="http://www.dicorproducts.com">www.dicorproducts.com</a>	(800) 837.2059	12 year / 5 year	1 Year
Shore Line Power Cord	Dave Carter & Assoc.	<a href="http://www.davecarter.com">www.davecarter.com</a>	(574) 522-2857	1 Year	1 Year
Shower - Fiberglass	Frontline Manufacturing	<a href="http://www.diamondtubshowers.com">www.diamondtubshowers.com</a>	(574) 453-2902	3 Year	1 Year
Sidewall	Grand Design RV	<a href="http://www.granddesignrv.com">www.granddesignrv.com</a>	(574) 825-8000	3 Year	3 Year
Slide Out System - Hydraulic	Lippert Components	<a href="http://www.lci1.com">www.lci1.com</a>	(866) 524-7821	1 Year	1 Year
Slide Out System - Schwintek	Lippert Components	<a href="http://www.lci1.com">www.lci1.com</a>	(866) 524-7821	1 Year	1 Year
Smoke Detector	BRK Industries	<a href="http://www.brkelectronics.com">www.brkelectronics.com</a>	(800) 323-9005	10 Year	1 Year
Sofa	Lippert/Seat Tech	<a href="http://www.lci1.com">www.lci1.com</a>	(866) 524-7821	1 Year	1 Year
Sofa - Hide-a-Bed	Lippert/Seat Tech	<a href="http://www.lci1.com">www.lci1.com</a>	(866) 524-7821	1 Year	1 Year
Sound Bar	Patrick Industries	<a href="http://www.patrickind.com">www.patrickind.com</a>	(574) 294-7511	1 Year	1 Year

Continued on next page

## Component Manufacturer List

<b>Momentum Component Manufacturer's Warranty Information</b>					
Component	Component Manufacturer	Component Manufacturer Website	Component Manufacturer Phone	Component Manufacturer Warranty Period	Grand Design Limited Warranty
Speakers - Exterior	Mid West Sales	<a href="http://www.midwest.org">www.midwest.org</a>	(574) 287-3365	1 Year	1 Year
Speakers - Exterior	ASA Electronics	<a href="http://www.asaelectronics.com">www.asaelectronics.com</a>	(877) 305-0445	1 Year	1 Year
Speakers - Exterior	ASA Electronics	<a href="http://www.asaelectronics.com">www.asaelectronics.com</a>	(877) 305-0445	1 Year	1 Year
Speakers - Interior	Mid West Sales	<a href="http://www.midwest.org">www.midwest.org</a>	(574) 287-3365	1 Year	1 Year
Stabilizer Jacks, Rear Electric	Lippert Components	<a href="http://www.lci1.com">www.lci1.com</a>	(866) 524-7821	1 Year	1 Year
Stabilizing Jacks, Front Manual	Lippert Components	<a href="http://www.lci1.com">www.lci1.com</a>	(866) 524-7821	1 Year	1 Year
Stereo	Estone	<a href="http://www.patrickind.com">www.patrickind.com</a>	(574) 294-7511	1 Year	1 Year
Suspension System	Lippert Components	<a href="http://www.lci1.com">www.lci1.com</a>	(866) 524-7821	1 Year	1 Year
Tank Heaters	Patrick Industries	<a href="http://www.patrickind.com">www.patrickind.com</a>	(574) 294-7511	1 Year	1 Year
Television	Sansui	<a href="http://www.sansui.com">www.sansui.com</a>	(800) 289-0980	1 Year	1 Year
Television	Magnavox	<a href="http://www.magnavox.com">www.magnavox.com</a>	(866) 341-3738	Ninety (90) day labor / one (1) year parts	1 Year
Television	Haier	<a href="http://www.haieramerica.com">www.haieramerica.com</a>	(877)-337-3639	1 Year	1 Year
Television	Furrion	<a href="http://www.furion.com">www.furion.com</a>	(888) 354-5792	1 Year	1 Year
Thermostat	Dometic	<a href="http://www.dometicusa.com">www.dometicusa.com</a>	(800) 544-4881	2 Year	1 Year
Tires	West Lake (Lionshead Specialty Tire & Wheel)	-	(574) 533-6169	1 Year	1 Year
Toilet	Thetford	<a href="http://www.thetford.com">www.thetford.com</a>	(574) 533-6169	1 Year	1 Year
TV Antenna	Antennatek	<a href="http://www.antennatek.com">www.antennatek.com</a>	(303) 772-9591	1 Year	1 Year
Water Heater	Suburban	<a href="http://www.rvcomfort.com">www.rvcomfort.com</a>	(423) 775-2131	2 Year	1 Year
Water Pump	Flo-Jet	<a href="http://www.flojet.com">www.flojet.com</a>	(714) 557-4700	2 Year	1 Year
Windows	Lippert/Kinro	<a href="http://www.lci1.com">www.lci1.com</a>	(866) 524-7821	1 Year	1 Year

As of 10/21/13

**NOTE: COMPONENT MANUFACTURER'S WARRANTIES STATED ABOVE WERE ACCURATE AT THE TIME OF PUBLICATION, HOWEVER THEY ARE SUBJECT TO CHANGE AT THE DISCRETION OF THE MANUFACTURER AT ANY TIME. PLEASE CONTACT THE MANUFACTURER DIRECTLY FOR CURRENT WARRANTY COVERAGE PROVISIONS.**

## **Occupant Safety**

Your RV is designed with comfort and safety as a priority. It complies with applicable codes and safety standards in effect at the time it was built. A number of required safety items are installed for your safety and the safety of other occupants of the RV. Before camping, please review and understand the locations of all safety equipment inside the RV and all emergency exit windows as well as doors. We encourage you to develop a family safety plan in case of an emergency or severe weather condition, and practice it with your entire family, especially children.

- Ask an out-of-state relative or friend to serve as the "family contact." Make sure everyone knows the name, address, phone number and email of the contact person.
- Draw a floor plan of your RV and find two ways to exit. There should be at least one way to get out of your RV without opening the door.
- Teach everyone what the RV safety alarm signals mean and how to be prepared to leave the RV by themselves if necessary.
- Teach how to check doors and not to open them if the doors are hot. Also teach everyone to stay low to try to avoid breathing smoke, fumes or gases.
- In case family members are separated from one another, have a plan for getting back together. Decide on a meeting place a safe distance from your RV and make sure everyone understands to wait there.
- Make sure everyone knows where to go to call the fire department or 911 from outside the RV.
- Conduct safety drills at least every six months to make sure everyone, including guests, knows what to do to escape safely. Practice evacuating the RV blindfolded; in a real fire situation, the amount of smoke generated may make it impossible to see.
- Consult your local fire department for additional safety precautions.

Pets may not be allowed into shelters for health and space reasons. Prepare an emergency plan for pets that includes at least a 3-day supply of dry food and a large container of water. The survival of a beloved pet often depends on the plans its owner has made in advance.

## **Emergency Weather Planning**

One of the more serious conditions you need to take into account when camping is that of the weather, which is subject

### **WARNING**

*During severe weather conditions move indoors to a place of safety or shelter as directed by the campground or appropriate authorities. Avoid trees or power lines that could fall on your vehicle. The safest place during severe weather conditions is inside a basement or storm shelter, not an RV or tow vehicle.*

### **WARNING**

*Be aware of the heat index if camping during hot weather. Keep yourself hydrated, and try to stay indoors in an air-conditioned area during a high heat index warning.*

## Occupant Safety



Familiarize yourself with the following weather terms:

*Warning - Indicates a particular weather hazard is either imminent or has been reported. Take action to protect life and property. Move to a safe location immediately. The type of hazard is reflected in the type of warning (i.e., tornado warning, blizzard warning, etc.).*

*Watch - Indicates a particular hazard is possible and that conditions are more favorable than usual for its occurrence. A watch is a recommendation for planning, preparation and increased awareness (i.e., to be alert for changing weather, listen for further information and think about what to do if the danger materializes).*



An emergency egress window has an affixed "exit" label. Do not remove this label from the window.

to change with little or no warning. Earthquakes, hail, flooding, hurricanes, wintry weather, tornadoes - these and other extreme weather conditions can threaten your safety and damage your tow vehicle or RV.

Local radio and TV stations normally broadcast weather conditions and warnings as they occur. Research other methods of learning about severe weather conditions and how to deal with them. You may want to consider investing in a weather radio. Weather radios offer 24 hour-a-day VHF broadcasts of weather observations and forecasts directly from the US National Weather Service (NWS). The frequencies used by the US National Oceanic and Atmospheric Administration (NOAA) weather radio stations are 162.400, 162.425, 162.450, 162.475, 162.500, 162.525 or 162.550 megahertz or visit their website at [www.noaa.gov](http://www.noaa.gov).

### *Repairing severe weather damage*

If your tow vehicle or RV is damaged due to severe weather damage, you will most likely need repair work. Call your insurance company as soon as you can to report your claim.

### **Emergency Egress Window**

The emergency egress window (or "exit window") is designed to allow a secondary means of quick exit if access to the main entrance door is not available. All egress windows are distinguishable by red operational handles or levers. Depending upon the window type, an egress window may be a large section or an entire window. Know how to open and operate the egress window before an emergency occurs:

- When pulling into your campsite, make sure the ground below the egress window is solid and there is a clear escape path directly outside all egress windows. Make sure the egress is not blocked by trees or other obstacles.
- Review the locations and operational instructions on the egress window label with all people staying in the RV.
- Plan fire escape routes.
- Decide who will exit through the emergency escape windows first, and in what position.
- Place a blanket or heavy coat over the window frame to cushion the exit.
- If there is a fire, the last person to exit the RV should be prepared to assist those in front.
- Arrange for a meeting place safely away from the RV.

### *Maintenance*

Occasionally open the windows to prevent the seals from sticking. The egress window must be locked during transit.



## **Fire Safety**

If a fire starts, execute your family safety plan. Make sure everyone knows to stop, drop to the ground and roll back and forth, shielding their face from the fire with their hands, if their clothes catch fire. Learn and teach safe fire practices. Build campfires away from nearby trees or bushes. Maintain at least a three-foot clear area free of leaves, dry grass, pine needles, etc., around grills, campfires and/or tents. Supervise children at all times when campfires are burning or grills are in use. Always have a way to extinguish the campfire quickly and completely. Never leave a fire - even a cigarette - burning unattended.

Teach family members how to use the fire extinguisher and replace it as recommended. Do not store combustible materials in closed areas or near a heat source. Do not attempt to use water to put out a grease fire. Water can spread some types of fire and create an electrocution hazard during an electrical fire.

Always call the Fire Department, no matter how small the fire. However, be aware that if a fire threatens your RV, you should not place the call to your emergency services from inside the RV. It is better to get out first and place the call from somewhere else. More information on firefighting can be found at the National Fire Protection Association website ([www.nfpa.org](http://www.nfpa.org)).

## **Fire Extinguisher**

A portable fire extinguisher can save lives and property by putting out a small fire or containing it until the fire department arrives; but portable extinguishers have limitations. It is important to recognize when to leave the RV. Because fire grows and spreads so rapidly, the number one priority is to get out safely. The Underwriter Laboratories (UL) classify household fire extinguishers into four types:

Rating	Intended Use
<b>Type A</b>	For use on fires involving combustible materials such as wood, cloth and paper.
<b>Type B</b>	For use on flammable liquid fires, including kitchen grease. Never use water on this type of fire!
<b>Type C</b>	For use in fires involving energized electrical equipment.
<b>Type ABC</b>	Works on all three types of fires listed above.

The factory-installed dry chemical fire extinguisher, suitable for extinguishing small fires of the Class B and Class C type, is located near the entry door.



*If you feel a fire was caused by product failure, contact Grand Design RV Customer Service at (574) 825-8000 immediately for approval before you clean any debris, enter, move or repair your RV (failure to notify Grand Design RV may result in loss of coverage).*

## **CAUTION**

*Avoid inhaling the dry chemical agent in the fire extinguisher. It is not toxic, but may cause skin irritation. In case of contact, flush the affected area with clean, cool water. If irritation persists, contact a physician immediately.*

## Occupant Safety



Typical smoke alarm



Do not remove the following labels from your RV:



Typical US smoke alarm label



Typical CSA smoke alarm label

### Operation

Keep your back to a clear exit when you use the fire extinguisher so you can make an easy escape if the fire cannot be controlled. If the room fills with smoke, leave immediately. Know when to leave. Fire extinguishers are one element of a fire response plan, but the primary element is safe escape. There are different types and sizes of fire extinguishers, but for the most part they all work the same way. To operate a fire extinguisher, remember the word **PASS**.

**P**ull the pin. Hold the extinguisher with the nozzle pointing away from you, and release the locking mechanism.

**A**im low. Point the extinguisher at the base of the fire.

**S**queeze the lever slowly and evenly.

**S**weep the nozzle from side-to-side until the fire is out.

### Disposal

Contact your local fire department, sanitation department or environmental protection department to find out what your local laws stipulate before disposing of your used (non-refillable) factory-installed dry chemical fire extinguisher.

### Smoke Alarm

Three of the most common fire safety issues are smoking in bed, leaving children unattended and cleaning with flammable fluids. There is no way to guarantee against injury or loss of life in a fire; however, the smoke alarm is intended to help reduce those risks. Individuals with medical problems, or who are hard of hearing, should consider using warning devices that provide both audible and visual signals. Proper use and care of your smoke alarm may save your life. Smoke alarms can only work if they are properly located, installed, operational and maintained and if smoke reaches them. They are not foolproof.

### Operation

The factory-installed ceiling mounted smoke alarm is operational once the 9-volt battery is correctly connected. The LED will flash to show the battery is supplying power to the alarm. When the product of combustion is sensed, the smoke alarm sounds a loud alarm that continues until the air is cleared.

### If this alarm sounds

During an alarm, you will hear a loud, repeating horn pattern and the red LED will flash rapidly. If the alarm sounds and you are not testing the smoke alarm, it is warning you of a potentially dangerous situation that requires your immediate attention. Never ignore any alarm. Ignoring the alarm may result in injury or death. If the alarm sounds get everyone out of the RV immediately.

*How to test*

It is important to test the smoke alarm at least once every week to make sure it is working properly. Stand at arm's length from the alarm when testing. The alarm horn is loud and may be harmful to your hearing.

1. Press and hold the test button on the smoke alarm cover until the alarm sounds (the smoke alarm may continue to alarm for a few seconds after you release the button).
2. If it does not alarm, make sure the smoke alarm is receiving power and test it again.
3. If it still does not alarm, replace it immediately.

*Battery*

The smoke alarm will not function if the battery is missing, disconnected, dead, the wrong type of battery is used or the battery is installed incorrectly. When the 9-volt battery becomes weak, the smoke alarm will "chirp" (the low battery warning). If the low battery warning sounds, the battery **MUST** be replaced. Never disconnect the battery to silence the smoke alarm.

*Maintenance*

Clean the smoke alarm at least once a month by gently vacuuming the outside cover. Do not paint over the smoke alarm. Paint may clog the openings to the sensing chambers and prevent it from operating properly.

**Carbon Monoxide (CO)**

Carbon monoxide (CO) is an insidious poison. It is a colorless, odorless and tasteless gas. It can endanger lives even at low levels of concentration. Many cases of reported carbon monoxide poisoning indicate while victims are aware they are not well, they become so disoriented they are unable to save themselves by either exiting or calling for assistance. Young children and household pets may be the first affected.

The following symptoms may be related to CO POISONING. Discuss these symptoms with ALL household members and RV guests:

Mild exposure: headaches, running nose, sore or watery eyes, often described as "flu-like" symptoms.

Medium exposure: dizziness, drowsiness, vomiting.

Extreme exposure: unconsciousness, brain damage and death



*During testing, you will hear a loud, repeating horn pattern and the red LED will flash rapidly on the smoke alarm.*

**WARNING**

*Never use an open flame from a match or lighter to test the smoke alarm; you may accidentally ignite and set fire to the smoke alarm and your RV. If the smoke alarm does not test properly, replace it immediately.*



Typical combination carbon monoxide (CO)/propane alarm.



Do not remove the following combination alarm label from your RV:



CO gas is produced when any type of fuel is incompletely burned. Potential sources of CO in and around your RV can include gas or diesel engine exhaust, portable space heaters, gas stoves and ovens, furnaces, defective engine exhaust systems, portable grills, other nearby RVs, portable generators, generator exhaust, and other propane-powered appliances.

### Combination Carbon Monoxide/Propane Alarm

Your RV is equipped with a combination carbon monoxide (CO)/propane alarm listed for use in recreation vehicles that will only work if it is operational and maintained. It has two electronic self-cleaning sensors that operate independently of each other.

It is designed to sense the presence of carbon monoxide and propane gas, however there are other combustible fumes or vapors that may be detected by the sensor including (but not limited to ): acetone, alcohol, butane and gasoline. These chemicals can be found in commonly used items such as deodorants, colognes, perfumes, adhesives, lacquer, kerosene, glues, wine, liquor, most cleaning agents and the propellants of aerosol cans.

High temperatures can activate glue and adhesive vapors. If you close up an RV on a hot day, the chemicals used in its construction may be detected months after the RV was built (see Formaldehyde).

#### *Combination Alarm Operation*

The combination alarm will operate normally down to 7-volts DC., do not operate it below 7-volts DC. Each time the combination alarm is first powered up:

- The CO sensor requires a ten (10) minute initial warm-up period to clean the sensor element and achieve stabilization. The GREEN LED indicator will flash on and off during the 10 minute warm-up period. The alarm cannot go into a CO alarm during this warm-up period. To test your alarm during the warm-up period, press the test button. After the warm-up period, the GREEN power ON indicator should glow continuously. If the ON indicator light does not light refer to the troubleshooting section, and contact your dealer for assistance - do not attempt to fix the combination alarm yourself.
- The propane alarm has a warm-up period of approximately one (1) minute. The combination alarm cannot go into a gas alarm during the warm-up period; however, after 1 minute the alarm can detect explosive gas.

- Simultaneous CO and gas alarms - Because the risk of a propane gas explosion is generally a more serious danger, the combination alarm unit gives the gas alarm a higher priority during simultaneous alarm condition. If the combination alarm generates alarms for both gas and CO at the same time, the gas LED will flash RED and the beeper will sound. The CO LED will be a solid RED until the CO is ventilated out of the RV, at which time the LED will return to the GREEN operational/safe color.

The combination alarm has two indicator lights that display a specific color for each monitored condition. There also is a matching sound pattern for alarm conditions.

- CO ALARM: The RED CO LED will flash and the alarm will sound four (4) "BEEPS" then silent for five (5) seconds. These signals indicate that the CO level is over 35 ppm. IMMEDIATE ACTION IS REQUIRED, see Procedures To Take During An Alarm. This cycle will continue until the TEST/Mute button on the front of alarm is pressed. Ventilate the RV. The RED light will stay ON until the CO has cleared, or the alarm will reactivate in approximately six (6) minutes if the CO is still present. DO NOT RE-ENTER THE RV. This alarm will return to normal operation after the RV is properly ventilated.
- PROPANE GAS ALARM: The RED LED will flash and the alarm will sound a steady tone whenever a dangerous level of propane or methane gas is detected. IMMEDIATE ACTION IS REQUIRED, see Procedures Take During A Gas Alarm. The detector will continue to alarm until the Test/Mute switch on the front of the alarm is pressed. Ventilate the RV. The RED gas LED will continue to flash until the gas has cleared, or the gas alarm will reactivate in approximately five (5) minutes if the gas is still present. DO NOT RE-ENTER THE RV. This alarm will return to normal operation after the RV is properly ventilated.
- MALFUNCTION/SERVICE SIGNAL: If any malfunction is detected, the gas LED will remain off and the Operational/CO LED will alternate RED/GREEN and the alarm will sound once every fifteen (15) seconds. Press the Test/Mute button. If the Test/Mute button does not clear the signals, check the auxiliary battery voltage. If the auxiliary battery voltage is not low and the combination alarm will not return to normal operation, immediately remove the alarm and return for service or warranty replacement.

## WARNING

*THIS COMBINATION ALARM WILL NOT WORK WITHOUT POWER; it is wired directly to the RV 12-volt electrical system with continual power being supplied by the auxiliary battery. If a battery cable is disconnected at the battery terminal, this alarm will not work.*

*THIS ALARM MAY NOT ALARM AT LOW CO LEVELS. Individuals with medical problems may consider using warning devices, which provide audible and visual signals for CO concentrations under 30 ppm.*

*THIS ALARM MAY NOT BE HEARD. The alarm's loudness is designed to meet or exceed regulatory standards; however, the alarm may not be heard if alarms are located in remote locations or behind closed doors. Persons who are hard-of-hearing, have consumed alcoholic beverages, taken prescription, non-prescription or illegal drugs, may not hear the alarm.*

*THIS ALARM WILL ONLY INDICATE THE PRESENCE OF GAS AT THE SENSOR. CO or explosive propane/natural gas gases may be present in other areas. Do not block or cover the alarm with any object that can prevent a gas leak or carbon monoxide from reaching the sensor.*

**⚠️ WARNING**

Actuation of the combination alarm may indicate the presence of carbon monoxide (CO) or propane gases, which can KILL YOU.

**⚠️ CAUTION**

If the combination alarm activates due to carbon monoxide or propane, DO NOT RE-ENTER THE RV UNTIL THE PROBLEM IS CORRECTED. Contact your dealer for assistance.

OPERATION	AUDIBLE SIGNAL	VISUAL SIGNAL
Normal	None	Steady green
CO alarm	4 “beeps 5 seconds off	Steady red
Propane alarm	Constant	Flashing red
Alarm malfunction	Beep every 30 seconds	Alternating red/green
End of life	Beeps every 25-30 seconds	Red red green green flashing

*Procedures to take during a gas alarm*

1. Turn off all gas appliances (stove, heater, furnace, refrigerator, etc.), extinguish all flames and smoking material.
2. Press the Test/Mute switch. DO NOT DISCONNECT POWER.
3. Evacuate the RV. Make sure everyone is accounted for.
  1. Leave the door and windows open.
  4. Turn off the propane tank valve.
  5. Determine and repair the source of the leak. Contact your dealer or get professional help if necessary.

*Procedures to take during a CO alarm (USA)*

If signal sounds (4 beeps and flashing or solid red light):

1. Operate the Test/Mute button.
2. Call your emergency local service, fire department or 911.
3. Immediately move to fresh air (outdoors or by an open door/window). Check that all persons are accounted for. Do not reenter the premises or move away from the open door/window until the emergency responders have arrived, the premises have been aired out and your alarm remains in its normal operation.
4. After following steps 1-3, if your alarm reactivates within a 24-hour period, repeat steps 1-3 and call a qualified appliance technician to investigate for sources of CO from fuel burning equipment and appliances, and inspect for proper operation of this equipment. If problems are identified during this inspection have the equipment serviced immediately. Note any combustion equipment not inspected by the technician and consult the manufacturers’ instructions, or contact the manufacturer directly, for more information about CO safety and this equipment. Make sure that the motor vehicles are not, and have not been, operating in an attached garage or adjacent to the residence.

*Procedures to take during a CO alarm (Canada)*

If signal sounds (4 beeps and flashing or solid red light):

Operate the Test/Mute. Immediately move to fresh air (outdoors or by an open door/window).

1. Check that all persons are accounted for. Do not reenter the premises or move away from the open door/window until the emergency responders have arrived, the premises have been aired out, and your alarm remains in its normal condition;
2. Call your emergency local service, fire department or 911.

Do not remove the following label from your RV:

**PEEL OFF AND PLACE THIS LABEL NEAR THE CO ALARM. WRITE IN YOUR EMERGENCY SERVICES AND APPLIANCE TELEPHONE NUMBERS.**

**PROCEDURES TO TAKE DURING AN ALARM**

**⚠ WARNING:** Actuation of your CO alarm indicates the presence of carbon monoxide (CO) which can KILL YOU. If the alarm sounds; **1)** Operate the reset /silence button; **2)** Call your emergency services (Phone Number \_\_\_\_\_) (fire department or 911); **3)** Immediately move to fresh air - outdoors or by an open door/window. Do a head count to check that all persons are accounted for. Do not reenter the premises nor move away from the open door/window until the emergency responders have arrived, the premises have been aired out, and your alarm remains in its normal operation. **4)** After following steps 1-3, if your alarm reactivates within a 24 hour period, repeat steps 1-3 and call a qualified appliance technician. (Phone Number \_\_\_\_\_) to investigate for sources of CO from fuel burning equipment and appliances, and inspect for proper operation of this equipment. If problems are identified during this inspection have the equipment serviced immediately. Note any combustion equipment not inspected by the technician and consult the manufacturers' instructions, or contact the manufacturer directly, for more information about CO safety and this equipment. Make sure that the motor vehicles are not, and have not been, operating in an attached garage or adjacent to the residence.

MTI Label No. WL10982

*Test Procedure*

To reduce the risk of CO poisoning or propane gas explosion, test the combination alarm operation after the RV has been in storage, before each trip and at least once per week during use. The TEST/RESET button tests all ELECTRICAL functions of the alarm. It does not check the sensor operation:

- You may use propane or butane gas to test the gas sensor. Note it may take up to 10 seconds for the alarm to sound.
- To test the CO sensor use a can of SAFE-T-ALERT CO test gas to test the 400 ppm calibration point. DO NOT TRY TO GENERATE CO TO TEST THE ALARM.

Press and hold the TEST/Mute switch (located on the front of the alarm) for one (1) second. The alarm is working properly if the GREEN indicator light changes color to RED and the horn beeps 4 times. The Gas LED should also blink Red.

**IMPORTANT! If this alarm does not test properly return it immediately for repair or replacement.**



**PEEL OFF AND PLACE THIS LABEL NEAR THE SOURCE OF FRESH AIR WHERE YOU PLAN TO GATHER AFTER AN ALARM. WRITE IN YOUR EMERGENCY SERVICES AND APPLIANCE TELEPHONE NUMBERS.**

**PROCEDURES TO TAKE DURING AN ALARM**

**⚠ WARNING:** Actuation of your CO alarm indicates the presence of carbon monoxide (CO) which can KILL YOU. If the alarm sounds; **1)** Operate the reset/silence button; **2)** Call your emergency services (Phone Number \_\_\_\_\_) (fire department or 911); **3)** Immediately move to fresh air - outdoors or by an open door/window. Do a head count to check that all persons are accounted for. Do not reenter the premises nor move away from the open door/window until the emergency responders have arrived, the premises have been aired out, and your alarm remains in its normal operation. **4)** After following steps 1-3, if your alarm reactivates within a 24 hour period, repeat steps 1-3 and call a qualified appliance technician. (Phone Number \_\_\_\_\_) to investigate for sources of CO from fuel burning equipment and appliances, and inspect for proper operation of this equipment. If problems are identified during this inspection have the equipment serviced immediately. Note any combustion equipment not inspected by the technician and consult the manufacturer's instructions, or contact the manufacturer directly, for more information about CO safety and this equipment. Make sure that the motor vehicles are not, and have not been, operating in an attached garage or adjacent to the residence.

MTI Form No. WL10981

*As the owner of the new RV, read and place the above label (shipped loose in your Owner Information Package) as directed.*



*If you have any questions regarding the health effects of formaldehyde or any other air pollutants, **always** consult your doctor or local health department.*

### *How to take care of your alarm*

The combination CO/propane gas alarm is designed to be as maintenance free as possible. To keep your alarm in good working order:

- Test the alarm weekly.
- Vacuum the dust off the alarm cover. At least once a year (more frequently in dusty locations) use the soft brush attachment of your vacuum to clean the alarm cover.
- Clean the alarm cover when it is dirty. Wash the alarm cover by hand using a cloth dampened in clean water. Dry with a soft cloth.
- Do not spray cleaning agents or waxes directly onto the front panel. This action may damage the sensor, cause an alarm or cause an alarm malfunction.
- Observe the color of the indicator light. At frequent intervals and during your weekly test, check the indicator light on the front panel of the alarm.

### **Indoor Air Quality**

Good indoor air quality is essential for long-term enjoyment of your RV. To maintain good air quality you need to be attentive to proper ventilation of your RV, keeping the RV clean, and avoiding unnecessary air pollutants. Common indoor air pollution sources include molds, pollen, dander from pet fur, secondhand smoke, carbon monoxide from burning propane and other fuels (and charcoal), and household cleaners.

Inadequate ventilation can increase indoor pollutant levels by not bringing enough outdoor air to dilute emissions from indoor sources and by not carrying indoor air pollutants outside. High temperatures and humidity levels can also increase concentrations of some air pollutants. Those people most at risk for poor indoor air quality include: people with asthma, people with allergies, people who have chronic lung diseases such as bronchitis and emphysema, people with pre-existing heart disease, children, and the elderly.

1. Breathe fresh air
  - Open windows.
  - Spend as much time outside as you can, in fresh air.
2. Control mold
  - Clean your bathroom and kitchen often to fight mold.
  - Fix any water leaks.
  - Clean up any mold you see or smell with a mix of no more than 1 cup of bleach mixed with 1 gallon of water. Never mix bleach with ammonia.

Close windows and run your air conditioner (AC) or your dehumidifier to help control mold.



3. Other ways to improve air quality
  - Clean often to get rid of dust and pet fur which can irritate your nose and throat.
  - Try not to use bug spray inside your trailer.
  - DO NOT SMOKE INSIDE YOUR RV. In addition to causing damage to your RV, tobacco smoke releases formaldehyde and other air pollutants.

#### *EPA Recommendations*

There are three basic strategies recommended by the Environmental Protection Agency (EPA) to improve indoor air quality:

- **Remove sources:** The most effective way to improve indoor air quality is to eliminate sources of pollution or reduce their emissions. Pollutants that this strategy can have an impact upon are: (i) Biological contaminants such as bacteria, molds, mildew, viruses, animal dander, and pollen, (ii) Household products such as paints, varnishes, cleaning and disinfecting solutions, cosmetics and hobby products, and (iii) Pesticides.
- **Ventilation:** To reduce or lessen exposure to chemicals from off-gassing it is of utmost importance that you ventilate your RV. Ventilation should occur frequently after purchase and at times when the temperatures and humidity are elevated.

Remember off-gassing is accelerated by heat and humidity. Open windows, exhaust vents, and doors. Operate ceiling and/or other fans, roof air conditioners, and furnaces and use a fan to force stale air out and bring fresh air in. Decreasing the flow of air by sealing RV increases the presence of indoor air pollutants.

Please also follow the recommendations contained in this manual regarding tips to avoid condensation problems. Many of the recommendations contained in the manual will assist in avoiding exposure to chemicals that off-gas.

- **Air Cleaners:** Air cleaners are designed to remove particles from the air. There are many types and sizes of air cleaners on the market. However, air cleaners are not generally designed to remove gaseous pollutants. The effectiveness of an air cleaner depends on how well it collects pollutants from indoor air and how much air it draws through the cleaning or filtering element.



*Chemical off-gassing is not a “defect” in your RV and is not covered by the Limited Base Warranty or Limited Structural Warranty. Please follow the recommendations in this section to address this concern.*

### **Chemical Sensitivity**

After you first purchase your new RV, and sometimes after it has been closed up for an extended period of time, you may notice a strong odor and chemical sensitivity. This is not a defect in your RV. Like your home, there are many different products used in the construction of RVs such as carpet, linoleum, plywood, insulation, upholstery, etc. Formaldehyde is also the by-product of combustion and numerous household products, such as some paints, coatings and cosmetics.

However, RVs are much smaller than your home and therefore the exchange of air inside a RV is less than a home. These products, when new or when exposed to elevated temperatures and/or humidity may “off-gas” different chemicals, including formaldehyde. This off-gassing, in combination with the minimal air exchange, may cause you to experience irritation of the eyes, nose, and throat and sometimes headache, nausea, and a variety of asthma-like symptoms. Elderly persons and young children, as well as anyone with a history of asthma, allergies or lung problems, may be more susceptible to the effects of off-gassing.

### **Formaldehyde**

Most of the attention regarding chemical off-gassing surrounds formaldehyde. Formaldehyde is a naturally occurring substance. It is also a key industrial chemical used in the manufacture of the numerous consumer products that we referred to previously and used in the construction of RVs.

Trace levels of formaldehyde are also released from smoking, cooking, use of soaps and detergents such as carpet shampoos, cosmetics, and many other household products. Some people are very sensitive to formaldehyde while others may not have any reaction to the same levels of formaldehyde. Amounts released decrease over time.

#### *California Air Resource Board (CARB) Notice*

Formaldehyde is used widely in building materials such as pressed wood products, particleboard, hardwood plywood paneling, medium density fiberboard (MDF), and plywood which are commonly used throughout the Recreational Vehicle Industry. As mandated by the RV Industry, Grand Design RV recreation vehicles contain composite wood products (hardwood plywood, particle board, and MDF) that comply with the California Air Resource Board (CARB) formaldehyde emission standards under California Code of Regulations § 93120.2(a) Phase 2 (P2).

## **Effects of Prolonged Occupancy**

Your RV was designed primarily for recreational use and extended stay use. If you expect to occupy your RV for an extended period, be prepared to deal with condensation and the humid conditions that may be encountered. The relatively small volume and tight compact construction of modern RVs mean that normal living activities of even a few occupants will lead to rapid moisture saturation of the air contained in the RV and the appearance of visible moisture, especially in cold weather.

## **Condensation**

Just as moisture collects outside of a glass of cold water during humid weather, moisture can condense on the inside surfaces of the RV during cold weather when relative humidity of the interior air is high. This condition is increased because the insulated walls of a RV are much thinner than house walls. Estimates indicate a family of four can vaporize up to three gallons of water daily through breathing, cooking, bathing and washing.

Unless the water vapor is carried outside by ventilation, or condensed by a dehumidifier, it will condense on the inside of windows and walls as moisture, or in cold weather as frost or ice. It may also condense out of sight within the walls or the ceiling where it will manifest itself as warped or stained panels. Appearance of these conditions may indicate a serious condensation problem. When using your RV, you should at all times take necessary action to minimize the effects of excessive moisture and condensation.

### *Tips to Controlling Condensation*

To avoid condensation problems, try to follow these tips to help alleviate excess moisture.

- Allow excess moisture to escape to the outside when bathing, washing dishes, hair drying, laundering and using appliances and non-vented gas burners.
- Keep the bathroom door closed and roof vent opened (if equipped, exhaust fan on) when bathing/showering and for a period of time after you have finished.
- When cooking, always operate the range hood fan. Cooking releases heat and moisture that can quickly result in condensation in your RV; operating the range hood fan can be effective in removing both.
- Do not hang wet clothes in the RV to dry.
- In hot weather, start the air conditioner early as it removes excess humidity from the air while lowering the temperature.



*Your RV is not designed, nor intended, for use as permanent housing. Use of this RV for long term or permanent occupancy may lead to premature deterioration of structure, interior finishes, fabrics, carpeting and drapes. Damage or deterioration due to long-term occupancy is not considered normal, and may under the terms of warranty, constitute misuse, abuse or neglect, and therefore void certain warranty protections.*



*If the tips presented here are not effective in controlling condensation, it may be necessary for you to invest in a dehumidifier to reduce the health risk to you or your family as well as prevent damage to your RV.*

- Manage the inside temperature during cold weather. The higher inside temperature along with colder outside temperatures will cause condensation to form on areas that are not insulated as well as others (windows, vents, wall studs, etc.).
- Use a fan to keep air circulating inside the vehicle so condensation and mildew cannot form in dead air spaces. Allow air to circulate inside closets and cabinets (leave doors partially open) so the temperature inside the cabinets the same as in the rest of the unit. Please keep in mind that a closed cabinet full of stored goods prevents circulation and can cause condensation.

The natural tendency would be to close the RV tightly during cold weather. This will actually compound the problem. Simply put, you need to get the moisture in the air that is created from normal use outside. The most effective way is utilizing your vents and vent fans.

### *Where There is Moisture, There May Be Mold*

Molds are microscopic organisms that naturally occur in virtually every environment, indoors and out. Outdoors, mold growth is important in the decomposition of plants. Left unchecked, molds break down natural materials such as wood products and fabrics.

According to the Center for Disease Control, exposure to damp and moldy environments may cause a variety of health defects, or none at all. Some people are sensitive to molds. For these people, molds can cause nasal stuffiness, throat irritation, coughing or wheezing, eye irritation or, in some cases, skin irritation. People with mold allergies may have more severe reactions. Immune-compromised people and those with chronic lung illnesses, such as obstructive lung disease, may get serious infections in their lungs when they are exposed to mold.

For mold growth to occur temperatures must be between 40 degrees and 100 degrees Fahrenheit, and there must be a source of moisture such as humidity, standing water, damp materials, etc. Indoors, the most rapid growth occurs with warm and humid conditions.

By controlling relative humidity, the growth of mold and mildew can be inhibited. In warm climates, use of the air conditioner will reduce the relative humidity. Vents are located in the bathing and cooking areas and constant use is advised during food preparation and bathing, even during colder weather. Additionally, opening a window during these activities will assist in ventilation. In extremely humid conditions, the use of a dehumidifier can be helpful.

Frequent use of your RV or cleaning regularly is an important preventative measure. Further, any spills should be wiped up quickly and dried as soon as possible. Avoid leaving damp items lying about. On safe surfaces, use mold or mildew killing cleaning products. Check sealants regularly, and reseal when necessary to avoid water leaks. Proper preventative maintenance to the RV and its accessories, as described both in this manual and in accompanying literature, will provide the best protection to the RV.

### **Cold Weather Usage**

Proper care should be taken when planning to use your RV in cold weather. Please keep in mind that your RV was not designed for use during sub-freezing weather. When used in freezing or below freezing temperatures, the following precautions need to be taken:

- More protection will be needed to protect the fresh water and drainage systems to avoid freezing problems.
- Propane and sufficient power is needed for protection from possible freeze-ups on the propane regulator. Keep in mind that more frequent furnace operation will substantially increase battery draw and propane use.
- During cool weather usage, ventilation or the addition of a dehumidifier may be required to reduce condensation.
- Check outside extrusions on compartment doors, locks, slide outs, windows, vents, etc., for frozen moisture before operating to avoid damage to parts.

### **Websites of Interest**

We also recommend that you visit the following websites that maintain information about indoor air pollutants, including molds and formaldehyde, along with ways to improve indoor air quality:

- <http://www.epa.gov/iaq/pubs/insidestory.html>
- <http://www.atsdr.cdc.gov/toxfaqs/tf.asp?id=219&tid=39>
- <http://www.epa.gov/mold/moldguide.html>
- <http://www.rvia.org/FactsAboutFormaldehyde>

## **Website Usage Disclaimers**

Grand Design RV hereby disclaims and sets forth as follows:

### *Website Disclaimer of Warranty*

The services, information and materials on websites listed in this manual are provided 'AS IS' and Grand Design RV shall have absolutely no liability whatsoever in connection with these website services, information, external links or third party links on these websites. Your use of these websites are at your own risk. Grand Design RV shall have no liability whatsoever for any errors, omissions or inaccuracies in the information regardless of how caused or for delays or interruptions in delivery of the information: or any decision made or action taken or not taken in reliance upon the information furnished.

Grand Design RV accepts no responsibility or liability whatsoever with regard to information on these websites as the information is meant to be of a general nature only and is not intended to address the specific circumstances of any particular individual or entity.

The information provided is not necessarily comprehensive, complete, accurate or up to date; the information is sometimes linked to external sites over which Grand Design RV has no control and for which Grand Design RV assumes no responsibility: Grand Design RV shall have no liability for any loss or injury caused, in whole or in part, by its actions, omissions or negligence, or for any contingencies beyond its control in procuring, compiling or delivering any information. The information is not professional nor does it comprise legal advice (if you need specific advice, you should always consult a suitably qualified professional).

### *Disclaimer of Endorsement*

Any reference within external or third party links to any specific commercial products, process or service by trade name, trademark, manufacturer or otherwise, does not constitute or imply it's endorsement, recommendation or favoring by Grand Design RV. The appearance of external or third party links does not constitute endorsement by Grand Design RV of the linked web sites or the information, products or services contained therein. Grand Design RV does not exercise any editorial control over the information you may find at these locations. External or third party links may be provided for the convenience of the users of that website. Grand Design RV is not responsible for the availability or content of these external or third party sites and does not endorse, warrant or guarantee any products, services, information, centers or schools described or offered at these links.

### **Additional Safety Precautions**

**Tire Pressure** - Tire pressure should be checked before departing on any trip, regardless of how short it may be. Always refer to the Tire Information Label attached to your vehicle for proper tire inflation pressures.

**Wheel Torque** – Lug nut torque at every wheel should be checked before departing on any trip, regardless of how short it may be. Refer to the Tire & Wheel section of this manual for lug nut torque specifications and patterns. Always use a calibrated torque wrench to confirm proper torque.

**Propane Appliances & Equipment** – Be sure all propane equipment & appliance (including the tanks) are turned off before departing on a trip. Understand all propane safety warnings and follow component manufacturer recommended operating procedures. Because propane is flammable improper use may result in a fire or explosion.

**Passenger Safety** – Passengers should never be allowed to travel inside your recreational vehicle while in transit. Several states have very specific laws prohibiting this practice.

**Loading & Weight Distribution** – Distribute weight evenly throughout your vehicle. Heavier items should be located close to the floor in the center of your vehicle. Be sure to balance loads front to rear and side to side. Never exceed the Cargo Carrying Capacity and/or Gross Vehicle Weight Rating of your trailer.

**Towing** – Follow posted speed limits and adjust for road conditions, weather and the environment. Pay close attention to passing vehicles and the effect they can have on your tow vehicle & trailer, especially large trucks which create external forces on both as they pass. Slow down and use caution in high cross winds which also create external forces that can impact the stability of your tow vehicle & trailer. Any of the above can cause swaying or “fishtailing” which can lead to a loss of control resulting in serious injury or death.

**Generator Operation**– Always make sure generators (customer supplied) are operated in open outdoor areas where the exhaust can properly dissipate and not create a carbon monoxide danger. Windows and any other openings near the generator exhaust should be closed and sealed to prevent the permeation of exhaust gas.

**Air Quality** - Air quality can be managed through the proper ventilation of your vehicle at all times. Condensation formation is an indication that proper ventilation is not occurring. Normal

activities like cooking, bathing, cleaning and even breathing all add moisture to the air that will convert to condensation if not removed through proper ventilation. Condensation build up over time can lead to mold formation. In addition, proper ventilation allows for the escape of formaldehyde which is contained in some building materials as well as a by-product of combustion.



## **Pre-Travel Information**

To help ensure your traveling enjoyment, call ahead for tourist information in each area that you will be visiting or traveling through. To help eliminate frustration, make sure you obtain the most current road maps. Research and make sure there are no federal, state or local regulations that may prohibit you from fully enjoying your camping adventure.

- Arrange for someone to check your house periodically while you are away. Stop mail or newspaper delivery.
- If you intend to be away for more than two weeks, you may want to consider requesting police surveillance for your house.
- Carry an extra set of vehicle and house keys with you on a separate key ring.
- Be sure to renew your license if it has expired, or will expire during your trip.
- If you are planning to visit other countries, contact the consulate nearest the point at which you plan to enter that country for the specific and most current information (including rules for re-entering the United States).

**Always carry your vehicle registration, insurance policy card(s) and warranty registration.**

## **Tow Vehicle Disclaimer**

If you plan to tow your RV with a tow vehicle you already own, contact your automotive dealer to find out your vehicle towing capacity. If you plan to purchase a new tow vehicle, be certain to tell your automotive dealer the GVWR, size and type of RV that you will be towing (some tow vehicles can be purchased with an optional tow package). As a minimum requirement, the Gross Vehicle Weight Rating (GVWR) of your RV must not exceed your tow vehicle's towing rating.

*Some automotive manufacturers publish brochures that discuss towing considerations. Ask your automotive dealer how to obtain a copy of this information. If applicable, verify if the brochure ratings are listed "with" or "without" an optional tow package.*

## **Vehicle Labels**

Decals and data plates used throughout the RV aid in its safe and efficient operation; others give service instructions. Read all decals, data and instruction plates before operating your RV. If any decal, data or instruction plate is painted over, damaged or removed, it should be replaced.

## **WARNING**

*Grand Design RV disclaims any liability with respect to damages that may be incurred by a customer or owner of a Grand Design RV recreational vehicle as a result of the operation, use or misuse of a tow vehicle.*



*Keep a record of the 17-digit vehicle identification number (VIN) and your license number in the event theft or vandalism requires you to supply this information to the authorities*

**⚠ WARNING**

Exceeding a rating may result in unsafe conditions, potential damage, may void a warranty, may complicate an insurance claim, and in some cases, may violate a law.

**Weight Ratings & Definitions**

Ratings are limits established by Grand Design RV and our component manufacturers which are not to be exceeded. Exceeding a rating may result in unsafe conditions, potential damage, may void a warranty, may complicate an insurance claim, and in some cases, may violate a law.

**GVWR** (Gross Vehicle Weight Rating) - The maximum permissible weight of this trailer when fully loaded. It includes the maximum allowable weight at the trailer axle(s) plus the hitch (tongue/pin) weight.

**UVW** (Unloaded Vehicle Weight) - The weight of this trailer as manufactured at the factory. It includes all weight at the trailer's axle(s) and hitch. If applicable, it also includes full generator fluids, fuel, engine oil and coolants.

**CCC** (Cargo Carrying Capacity)

- U.S.: Equal to GVWR minus the UVW and LP gas weight. (Water is considered a component of cargo.)
- Canada: Equal to GVWR minus the UVW, full fresh (potable) water weight (including the water heater) and full LP gas weight.

**GAWR** (Gross Axle Weight Rating) - The maximum permissible weight on an axle(s) when fully loaded.

**Hitch (Tongue/Pin) Weight** - The weight of the trailer that is transferred to the hitch of the tow vehicle when hooked up.

For additional definitions, refer to the Glossary of Terms.

**Weight Labels**

Vehicle weight labels are affixed to your RV to help you make an informed decision before your purchase. Do not remove these labels. If the labels are missing, contact your dealer or Grand Design RV Customer Service for replacements.

*Federal Certification Label*

This label specifies maximum capacities for GVWR, GAWR and tires. It is located on exterior left front of the vehicle.

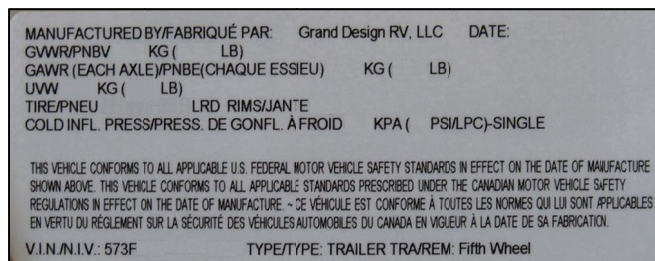

Typical federal certification label (US)

### *Tire and Loading Information label*

This label specifies the maximum amount of cargo that can be safely added to the RV. It is located on the exterior front left of the vehicle.

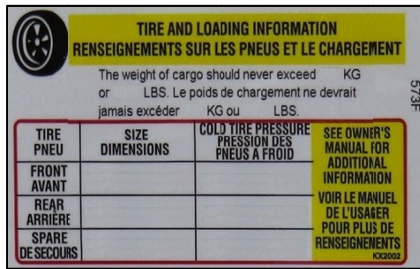

Typical tire and loading information label (US)

### *Cargo Carrying Capacity (CCC) label*

This label supplies the CCC information for the customer. It is located on the backside of an upper cabinet door in the kitchen area.

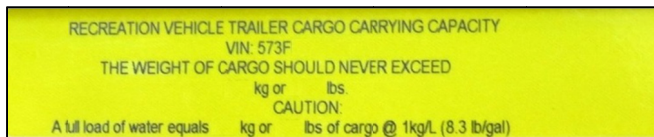

Typical cargo carrying capacity label (US)

## **Cargo Capacities**

Cargo can be added to the vehicle, up to the maximum weight specified on the placard. The combined weight of the cargo is provided as a single number. In any case, remember the total weight of a fully loaded RV cannot exceed the stated GVWR.

Water and propane also need to be considered:

- The weight of fully filled propane containers is considered part of the weight of the RV before it is loaded with cargo and is not considered part of the disposable cargo load.
- Water however, is a cargo weight and is treated as such. If there is a fresh water storage tank of 100 gallons, this tank when filled would weigh about 800 pounds.

If more cargo is being transported, water can be off-loaded to keep the total amount of cargo added to the vehicle within the limits of the GVWR so as not to overload the RV. Understanding this flexibility will allow you, the owner, to make choices that fit your travel and camping needs.

You may question the total weight capacity of the tires on your RV being less than the GVWR; this is correct. In order to calculate the actual weight on the RV tires, it is necessary to include the tongue weight. The tongue weight is actually being carried by your tow vehicle, not the RV tires.

## **⚠️ WARNING**

*The actual weight of the vehicle, all options, liquids, the hitch weight, and your personal cargo is important for you to know so you do not exceed the Gross Vehicle Weight Rating (GVWR) of the recreation vehicle. The volume of space available for storage may exceed the amount of available cargo capacity. Large storage compartments have been designed to accommodate normal camping items, which are bulky, but not necessarily heavy.*

## **WARNING**

Never load the RV in excess of the GAWR for either axle. Overloading the RV may result in adverse handling characteristics and damage to the chassis.

## **WARNING**

**DO NOT EXCEED YOUR GVWR!** This means you should weigh your RV as loaded for your normal travel to determine the actual weight. If you exceed the GVWR, you **MUST** remove items from the RV, or drain liquids, then reweigh the RV to ensure you have achieved a safe weight. Do not travel with full grey/black holding tanks. This not only wastes gas but, depending upon the location of the grey or black holding tanks, can affect handling characteristics.

## **WARNING**

Store items in areas designated for storage. Do not store anything in the areas reserved for the converter, electrical panels or the furnace or water heater, etc.

## **WARNING**

Your RV's load capacity is designated by weight, not by volume, so you cannot necessarily use all available space when loading the RV. Do not exceed your GVWR and ensure you are loading the vehicle as evenly as you can for the best possible handling. Ensure heavy items are secured so they do not shift during travel.

*For example: If the tires are rated at 2,000 lbs. each x 4 tires = 8,000 lbs. and the RV has a GVWR of 9,000 lbs. with a tongue weight of 1,200 lbs. The actual weight on the RV tires is 7,800 lbs., which is within the weight rating of the tires.*

If you have further questions, please contact your dealer or Grand Design RV Customer Service.

### **Loading Your RV**

Store and secure all loose items inside the RV before traveling. Overlooked items such as canned goods, or small appliances on the countertop, cooking pans on the range or free-standing furniture items can become dangerous projectiles during a sudden stop. Distribute cargo side-to-side so the weight on each tire does not exceed one-half of the GAWR for either axle. For traveling safety, it is important to make sure any tie down straps (if so equipped) on appliances or furniture are secured.

### **Weighing Your Tow Vehicle & RV**

There are two important factors when loading your RV, total weight and balance. It is imperative that you verify compliance within all applicable weight ratings. Overloading your RV will void the Limited Base Warranty and Limited Structural Warranty, and the warranties of many component part manufacturers. Have your RV weighed periodically at a public scale to determine the proper load distribution. Keep in mind that individual scales will operate differently. The surroundings of the scale need to be adequate to accommodate weighing each side of your RV.

#### *To weigh your tow vehicle and RV*

Read through all the weighing instructions before you begin. If you have further questions, consult with your dealer or the scale operator. Your RV must be weighed fully loaded (that is with food, clothing, fuel, water, propane, supplies, etc.).

1. Weigh the RV including the tongue weight, while detached from the tow vehicle. This actual overall weight must be less than or equal to the GVWR for safe operation. If the overall weight is greater than the GVWR, some contents must be removed until the actual overall weight is less than or equal to GVWR.
2. Hitch the RV to your tow vehicle. Weigh the RV and the tow vehicle to determine the Gross Combined Weight (GCW). Make sure that this rating is less than or equal to the GCWR as specified by the manufacturer of your tow vehicle. If this overall weight is greater than the Gross Combined Weight Rating (GCWR), some contents must be removed to bring the combination into compliance with the listed ratings.

3. Weigh the RV while attached to but excluding the tow vehicle. This will result in the actual weight that is exerted on all of the RV tires. This weight may be subtracted from the overall RV GVWR to determine the actual “tongue” weight.
4. With the RV still attached to the tow vehicle, weigh each wheel position separately to ensure each tire is not overloaded.

*To determine the wheel position weight:*

5. Pull the RV onto the scale so only one tire is on the scale. Record the weight. Your RV must remain as level as possible on the scale (even though an axle or side is not physically on the scale). Obviously, to obtain the side-to-side weights, there must be enough space on either side of the scale to accommodate the RV being partially off the scale.
6. To calculate the opposite side of the RV wheel position weight, subtract the first side’s weight from the weight determined in step #3.

If there is a difference in the weights on one side of the vehicle as compared to weights on the other side, components (tires, wheels, brakes, springs, etc.) on the heavier side could be overloaded, even though the total axle load is within the GAWR. It is important to redistribute the load to avoid component failure, improve the handling characteristics of the tow vehicle and not void the Limited Base Warranty and Limited Structural Warranty.

*With these actual weights, it is now possible to compare them against the Trailer Weight Information label weight ratings to ensure you are below the posted minimum ratings.*

### **Tire Safety Information**

This portion of the Owner’s Manual contains tire safety information as required by 49 CFR 575.6(4) and is based in part on the National Highway Traffic Safety Administration’s (NHTSA) brochure titled “Tire Safety, Everything Rides on It.” It can be obtained from NHTSA or downloaded, free of charge, at [http://www.NHTSA.dot.gov/cars/rules/TireSafety/ridesonit/tires\\_index.html](http://www.NHTSA.dot.gov/cars/rules/TireSafety/ridesonit/tires_index.html).

Studies of tire safety show that maintaining proper tire pressure, observing tire and vehicle load limits (not carrying more weight in your vehicle than your tires or vehicle can safely handle), avoiding road hazards, driving within the designated tire speed ratings, and inspecting tires for cuts, slashes, and other irregularities are the most important things you can do to avoid tire failure, such as tread separation or blowout and flat tires.

### **⚠️ WARNING**

*Total weight of your tow vehicle and RV must not exceed the GCWR. Do not assume that you can tow a RV that happens to be within the capacity of the tow vehicle hitch. By doing so, you may exceed the total GCWR of your tow vehicle and RV towing combination.*

### **⚠️ WARNING**

*It is important to redistribute the load to avoid component failure as well as to improve the handling characteristics of the vehicle.*

**⚠️ WARNING**

*Keep tires properly inflated. A tire that is run long distances or at high speeds while seriously under-inflated will overheat to the point where the tire may lose air suddenly and/or catch fire, possibly resulting in damage to the vehicle and its contents and/or personal injury.*

**⚠️ WARNING**

*Always check tire pressure when tires are cold. Cold tire inflation pressure is defined as a tire that has not been used for three or more hours, or has been driven less than one mile. Tire inflation pressure of a hot tire may show an increase of as much as 6 psi over a cold tire. Do not exceed the maximum recommended pressure.*

These actions, along with other care and maintenance activities, can also:

- Improve vehicle handling.
- Help protect you and others from avoidable breakdowns and accidents.
- Improve fuel economy.
- Increase the life of your tires.

Use this information to make tire safety a regular part of your vehicle maintenance routine. Recognize that the time you spend is minimal compared with the inconvenience and safety consequences of a flat tire or other tire failure.

**Safety First – Basic Tire Maintenance**

Properly maintained tires improve the steering, stopping, traction, and load-carrying capability of your vehicle. Under-inflated tires and overloaded vehicles are a major cause of tire failure. Therefore, as mentioned above, to avoid flat tires and other types of tire failure, you should maintain proper tire pressure, observe tire and vehicle load limits, avoid road hazards, and regularly inspect your tires.

**Recommended Tire Pressure & Load Limits**

Tire information placards and vehicle certification labels contain information on tires and load limits. These labels indicate the vehicle manufacturer’s information including:

- Recommended tire size
- Recommended tire inflation pressure
- Cargo weight (the maximum cargo weight a vehicle is designed to carry)
- Front and rear gross axle weight ratings (GAWR– the maximum weight the axle systems are designed to carry).

Both placards and certification labels are permanently attached to the trailer. See the “Weight Ratings Labels” in this section for location and detailed information.

**Understanding Tire Pressure & Load Limits**

Tire inflation pressure is the level of air in the tire that provides it with load-carrying capacity and affects the overall performance of the vehicle. The tire inflation pressure is a number that indicates the amount of air pressure, measured in pounds per square inch (psi), a tire requires to be properly inflated. (You will also find this number on the vehicle information placard expressed in kilopascals (kPa), which is the metric measure used internationally.)

Vehicle manufacturers determine this number based on the vehicle's design load limit, that is, the greatest amount of weight a vehicle can safely carry and the vehicle's tire size. The proper tire pressure for your vehicle is referred to as the "recommended cold inflation pressure." (As you will read below, it is difficult to obtain the recommended tire pressure if your tires are not cold.)

### *Checking Tire Pressure*

It is important to check your vehicle's tire pressure at least once a month for the following reasons:

- Most tires may naturally lose air over time.
- Tires can lose air suddenly if you drive over a pothole or other object or if you strike the curb when parking.
- With radial tires, it is usually not possible to determine under-inflation by visual inspection.

For convenience, purchase a tire pressure gauge to keep in your vehicle. Gauges can be purchased at tire dealerships, auto supply stores and other retail outlets.

### *Steps for Maintaining Proper Tire Pressure*

1. Locate the recommended tire pressure on the vehicle's Tire and Loading Information label located on the exterior front left side wall.
2. Record the tire pressure of all tires.  
If the tire pressure is too high in any of the tires, slowly release air by gently pressing on the tire valve stem with the edge of your tire gauge until you get to the correct pressure.
3. If the tire pressure is too low, note the difference between the measured tire pressure and the correct tire pressure. These "missing" pounds of pressure are what you will need to add.
4. At a service station or using an air compressor, add the missing pounds of air pressure to each tire that is under-inflated.
5. Check all the tires to make sure they have the same air pressure.

If you have been driving your vehicle and think that a tire is under-inflated, fill it to the recommended cold inflation pressure indicated on your vehicle's Tire and Loading Information label. While your tire may still be slightly under-inflated due to the extra pounds of pressure in the warm tire, it is safer to drive with air pressure that is slightly lower than the vehicle manufacturer's recommended cold inflation pressure than to drive with a significantly under-inflated tire. Since this is a temporary fix, do not forget to recheck and adjust the tire's



*Because tires are designed to be used on more than one type of vehicle, tire manufacturers list the "maximum permissible inflation pressure" on the tire sidewall. This number is the greatest amount of air pressure that should ever be put in the tire under normal driving conditions.*

pressure when you can obtain a cold reading.

### **Tire Safety Tips**

#### *Preventing Tire Damage*

- Slow down if you have to go over a pothole or other object in the road.
- Do not run over curbs or other foreign objects in the roadway or when parking.

#### *Tire Safety Checklist*

- Check tire pressure regularly (at least once a month), including the spare.
- Inspect tires for uneven wear patterns on the tread, cracks, foreign objects, or other signs of wear or trauma.
- Remove bits of glass and foreign objects wedged in the tread.
- Make sure your tire valves have valve caps.
- Check tire pressure before going on a long trip.
- Do not overload your vehicle. Check the Tire Information and Loading Label.







### **Tire Tread**

The tire tread provides the gripping action and traction that prevent your vehicle from slipping or sliding, especially when the road is wet or icy. In general, tires are not safe and should be replaced when the tread is worn down to 1/16 of an inch.

Tires have built-in tread-wear indicators that let you know when it is time to replace your tires. These indicators are raised sections spaced intermittently in the bottom of the tread grooves. When they appear “even” with the outside of the tread, it is time to replace your tires.

Another method for checking tread depth is to place a penny in the tread with Lincoln’s head upside down and facing you. If you can see the top of Lincoln’s head, you are ready for new tires.



	Condition	Possible Cause	Remedy
	Even Center Wear	Over-Inflation	Check & Adjust Pressure When Cold
	Inside & Outside Wear	Under-Inflation	Check & Adjust Pressure When Cold
	Smooth Outside Wear (One Side)	Loss of Camber or Over-Loading	Check & Unload as Necessary and / or Have Alignment Checked
	"Feathering" Across the Face	Axle Not Square to Frame or Incorrect Toe-In	Square Axles and / or Have Alignment Checked
	Cupping	Loose Bearings or Wheel Balance	Check Bearing Adjustment and Wheel & Tire Balance
	Flat Spots	Wheel Lock-Up	Adjust Brakes

**Tire Size**

To maintain tire safety, purchase new tires that are the same size as the vehicle’s original tires or another size recommended by the manufacturer. Look at the Tire and Loading Information label, or the sidewall of the tire you are replacing to find this information. If you have any doubt about the correct size to choose, consult with the tire dealer

**Tire Labeling**

Federal law requires tire manufacturers to place standardized information on the sidewall of all tires. This information identifies and describes the fundamental characteristics of the tire and also provides a tire identification number for safety standard certification and in case of a recall.

**Tire Size & Type Designation**

For example the tires on your unit may be marked with a designation of standard trailer (ST) 225/75R15 or light truck (LT)

235/85R16. The designation breakdown is as follows:

- The first three-digit number gives the width in millimeters of the tire from sidewall edge to sidewall edge. In general, the larger the number, the wider the tire.
- The next two-digit number after the “slash” mark, known as the aspect ratio, gives the tire’s ratio of height to width.
- R - The “R” stands for radial.
- The last two-digit number is the wheel or rim diameter in inches.

### **US DOT Tire Identification Number (TIN)**

This begins with the letters “DOT” and indicates that the tire meets all federal standards. The next two numbers or letters are the plant code where it was manufactured, and the last four numbers represent the week and year the tire was built. For example, the numbers 3197 means the 31st week of 1997. The other numbers are marketing codes used at the manufacturer’s discretion. This information is used to contact consumers if a tire defect requires a recall.

### **Tire Ply Composition & Materials Used**

The number of plies indicates the number of layers of rubber-coated fabric in the tire. In general, the greater the number of plies, the more weight a tire can support. Tire manufacturers also must indicate the materials in the tire, which include steel, nylon, polyester, and others.

### **Maximum Load Rating**

This number indicates the maximum load in kilograms and pounds that can be carried by the tire.

### **Maximum Permissible Inflation Pressure**

This number is the greatest amount of air pressure that should ever be put in the tire under normal driving conditions.

### **Speed Rating**

- Typically tires with a ST designation are speed restricted to 65 mph under normal inflation and load conditions.
- Typically tires with a LT designation are speed restricted to 75 mph under normal inflation and load conditions. **Do not exceed these speed ratings regardless of the posted maximum speed limit.**

**Tires are warranted by the tire manufacturer and not by Grand Design RV. In the event that you need tire warranty assistance, please contact your dealer or refer to the tire warranty pamphlets provided with your RV for details.**

## **How Overloading Affects Your RV and Tires**

The results of overloading can have serious consequences for passenger safety. Too much weight on your vehicle's suspension system can cause spring, shock absorber, or brake failure, handling or steering problems, irregular tire wear, tire failure or other damage. An overloaded vehicle is hard to drive and hard to stop. In cases of serious overloading, brakes can fail completely, particularly on steep hills. The load a tire will carry safely is a combination of the size of tire, its load range, and corresponding inflation pressure. Excessive loads and/or under-inflation cause tire overloading and, as a result, abnormal tire flexing occurs. This situation can generate an excessive amount of heat within the tire. Excessive heat may lead to tire failure.

It is the air pressure that enables a tire to support the load, so proper inflation is critical. Since RVs can be configured and loaded in many ways, air pressures must be determined from actual loads (determined by weighing) and taken from the load and inflation tables provided by the tire manufacturer. These air pressures may differ from those found on the certification label. However, they should never exceed the tire limitation for load or air pressure. If you discover that your tires cannot support the actual weights, the load will need to be lightened.

### *Steps For Determining Correct Load Limit*

1. Locate the statement "The weight of cargo should never exceed XXX KG or XXX LBS" on your RV's Cargo Carrying Capacity label.
2. This figure equals the available amount of cargo and luggage load capacity.

Determine the combined weight of luggage and cargo being loaded on the RV. That weight may not safely exceed the available cargo and luggage load capacity.

## **Spare Tire**

If equipped, the spare tire can be utilized in an emergency if a trailer tire loses air pressure or goes flat. Certain Grand Design RV brands may use different spare wheels than original with the intent for the spare to be temporary.

### *Tire Changing Basics*

1. Use emergency flares when near a road or highway.
2. Block the wheels on the opposite side from the tire you wish to change to prevent accidental movement.
3. Position a hydraulic jack on the frame close to the spring hanger. (Never attempt to use a stabilizer jack to lift the RV.)
4. Raise the trailer until the tire clears the ground.

## **DANGER**

*If the total weight of the RV exceeds the GVWR, the trailer is overloaded. Operating your RV while exceeding the specified weight ratings increases the risk of a crash, personal injury and death. It is necessary to remove payload (equipment, personal belongings, water, etc.) until the total weight of the RV no longer exceeds the GVWR before operating the RV.*

## **DANGER**

*If the weight on the trailer axles exceeds the GAWR, the axles are overloaded. Operating your RV while exceeding the specified weight ratings increases the risk of a crash, personal injury and death. It is necessary to remove or rearrange payload (equipment, personal belongings, water, etc.) until the axle weight no longer exceeds the GAWR before operating the unit. Not operating your RV within the designed weight ratings can damage your recreational vehicle which is not covered under warranty.*

## **WARNING**

*Exceeding the established weight ratings for the axles, running gear, tires and wheels can lead to failure that can affect motor vehicle safety and lead to property damage or damage to the RV.*



Do not remove the following label from your RV:



### **WARNING**

Always torque the wheel nuts to the wheel manufacturer's specifications. Over or under-torqued wheel nuts can cause the wheel to separate from the wheel mounting surface during operation, causing property damage, personal injury or loss of life.

5. Set a jack stand under the frame just to the rear of the tire being changed.
6. Follow the Wheel Nut Torque and Wheel Reinstallation instructions provided below.

### **Wheel Nut Torque**

Torque is the amount of rotating force applied to a fastener, such as a lug nut. The axle and wheel assemblies of your RV are designed differently than those on your car. The overall size, weight and center of gravity of a RV subject the wheels to pressures unique to trailering. During normal cornering, the tires and wheels experience a considerable amount of stress called "side-load". Therefore, the lug nuts on your RV require periodic torque maintenance.

Lug nut torque at every wheel should be checked before departing on any trip, regardless of how short it may be. Always use a properly calibrated torque wrench to confirm proper torque. Do not allow under or over torque on any wheel.

- If your RV has Lippert Axles, match the chart below to the wheel size installed on the RV to determine the correct torque for each stage.
- Tightening the fasteners should be done in stages, using the sequence shown.

Wheel Size	Stud Size	Torque Sequence		
		1st Stage	2nd Stage	3rd Stage
14"	1/2"	20-25	50-60	90-120
15"	1/2"	20-25	50-60	90-120
16"	1/2"	20-25	50-60	90-120
16.5" x 6.75"	1/2"	20-25	50-60	90-120
16"	9/16"	20-25	60-70	120-130
16.5" x 6.75"	9/16"	20-25	60-70	120-130
17.5" w/long nut	5/8"	50-60	100-120	190-210
17.5" w/flange nut	5/8"	50-60	150-200	275-325
14.5" Demount	1/2"	tighten sequentially to 85-95		

**NOTE:** All torque in ft.-lb.

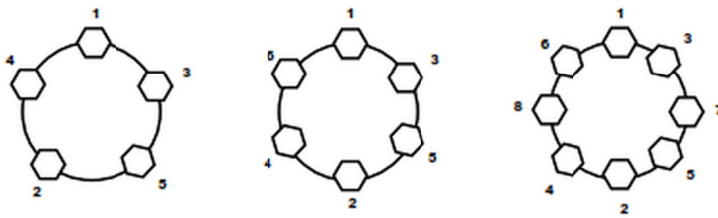

### **Emergency Stopping**

Always carry road flares or reflective warning signs to display if necessary. Pull off the roadway as far as possible for emergency stopping or tire changing. Turn ON your RV hazard warning flashers. If traveling at night, use three red warning indicators such as flares, reflectors or lanterns, as follows:

1. Place the first warning indicator on the traffic side of the RV, directed at the nearest approaching traffic.
2. Place the second warning indicator 100 feet behind the RV in the center of the lane and toward approaching traffic.
3. Place the third warning indicator 100 feet in front of the RV in the center of the lane and away from the traffic approaching from behind.

The hazard-warning flasher provides additional safety if the RV is stopped on the side of the roadway and presents a possible hazard to other motorists. When the flasher is on, it serves as a warning to others to approach and overtake your vehicle with caution.

**For personal safety, always stand off the road and out of the way of traffic. Curves and/or hills may affect the safe placement of warning indicators**

### **Emergency Towing**

If your RV needs to be towed, please contact an emergency road service provider or a qualified service facility for assistance.

This page is intentionally blank

## **Towing & Leveling**

Driving safety and protection against injury cannot be fully ensured; however, we recommend you pay special attention to the following:

- The use of daytime running lights can increase other motorists' awareness of the RV to all traffic.
- Keep the tires inflated to the specified levels. Replace the tires before they are excessively worn.
- Before changing lanes, check the outside rearview mirrors for other vehicles and activate the appropriate turn signal to alert other drivers.
- While driving, watch the behavior of other drivers, bicyclists and pedestrians. Always follow all traffic laws and regulations. Pay attention to traffic and road conditions. Be a courteous and alert driver. Always leave room for unexpected events, such as sudden braking.
- Never drive when you are sleepy or tired.
- Never drive when alcohol, drugs or medication have affected your judgment, reflexes or alertness.
- Obey all traffic laws and use your seatbelts at all times. Many states have lower speed limit requirements for tow vehicle/RV combinations. We recommend that you do not exceed the posted speed limit when towing an RV.
- Driving with the propane system on can add to the danger if you are involved in an accident or have a fire. Most refrigerators will keep food cold or frozen for eight hours without running while you travel. Shut the propane system off at the propane cylinder.
- Adverse weather conditions and extremes in terrain may affect the performance and handling of your tow vehicle. Do not operate the tow vehicle cruise control on icy or extremely wet roads, winding roads, in heavy traffic or in any other traffic situation where a constant speed cannot be maintained.

### **RV Driving Schools & Seminars**

If you have any concerns about driving while towing a RV, consult an expert for specific RV driver education. There are private RV schools and some RV owner's organizations that offer driving seminars. The schedules and locations of the various RV driver education seminars and schools can be researched through RV-related publications and internet sites.

*Use caution when using the internet as a resource tool. Verify the information is from a credited and reliable source in the RV industry, and it pertains to your RV. If in doubt, contact your dealer for assistance.*

## **⚠️ WARNING**

*Do not leave children or pets unsupervised in or around the RV (even if children are secured by a child restraint system). They could:*

- *Injure themselves on parts of the RV.*
- *Unlock and open the entry door, or open the emergency exit window, and then possibly injure other persons or damage property.*
- *Get out of the RV and either injure themselves when doing so or they could be injured by passing vehicles.*
- *Be seriously or even fatally injured by prolonged exposure to extreme heat or cold.*

## **⚠️ WARNING**

*You must observe the law if you are driving when operating a cell phone in your tow vehicle. If it is permitted to operate a cell phone while the tow vehicle is in motion, you must only operate it when road and traffic conditions permit. You may otherwise be distracted from the traffic conditions, cause an accident and injure yourself and others.*

## **RV Braking System**

The RV brakes are designed to work with your tow vehicle brakes. To maintain proper braking performance, both the RV and tow vehicle brakes must be used together. Separate use of the braking systems will cause accelerated wear and damage. When your RV is new, it is impossible to adjust the brake shoes precisely. It takes approximately 1,000 miles and/or 50 medium to heavy stops to “burnish” fit or “seat” the shoes to the brake drum. After the initial break-in period, your brake shoes must be adjusted accurately for best performance and increased durability.

Braking system components include:

- Tow vehicle battery
- Brake controller
- Wire harness/connector plug
- Auxiliary batteries (see Electrical System)
- Breakaway switch

## **Tow vehicle battery**

The tow vehicle battery is the primary source of power for your RV’s brake operation. To ensure available power when needed, keep your tow vehicle battery and charging system working properly.

## **Battery isolator (customer supplied)**

You may want to consider the installation of a battery isolator on your tow vehicle as a convenience feature:

- It receives current from the tow vehicle alternator and controls distribution of energy to both the RV auxiliary battery and the tow vehicle battery.
- It serves as a check valve to prevent energy from being drawn from your tow vehicle chassis battery (so you can start your tow vehicle engine).

Your dealer can assist you with the selection, purchase and installation of this aftermarket part.

## **Brake Controller (customer supplied)**

The brake controller should be installed in the tow vehicle to work in conjunction with the RV electric brakes. Consult with your dealer or the brake controller OEM to decide what is right for your towing combination.

## **7-way Wire Harness/Connector Plug**

A 7-way wire harness/connector plug is wired into your FW to connect electrical power from the tow vehicle for travel. This supplies power to the RV brakes, tail lights, clearance lights,



turn signals, brake lights, etc. Wiring to operate your brakes must be the same size in both the tow vehicle and RV.

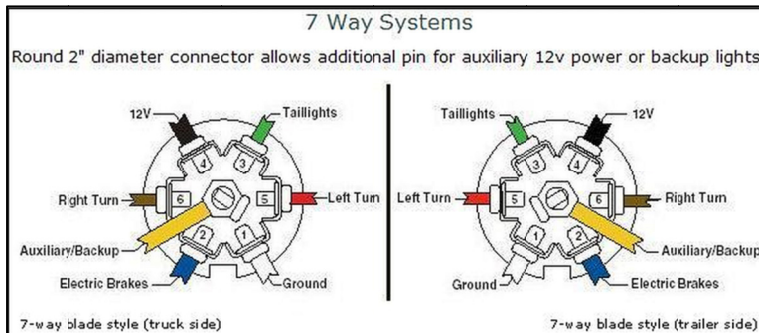

Typical 7-way wire harness wiring diagram

**Maintenance**

The connector plug may build up corrosion with extended use and should be cleaned periodically to insure good electrical contact. Make sure the connector plug is kept clean and protected from road elements as you travel.

**Breakaway Switch**

The breakaway switch is a crucial part of the RV braking system. Located by the FW pin box, this switch will apply the trailer brakes if the trailer becomes detached from the tow vehicle. Attach the breakaway switch lanyard to a permanent part of the tow vehicle when hitching the RV. If the RV becomes detached from the tow vehicle, the pull pin will be pulled from the switch., which automatically causes the switch to “close” and activate the RV brakes.

**An auxiliary battery (customer supplied) must be installed to activate the breakaway switch.**

**Fifth Wheel (FW) Pin Box**

Hitch selection is important because it affects the towing and handling characteristics of your RV. There are many kinds of hitches available for various uses and assuring that you have the correct hitch installed is critical to a safe towing experience. Ask your dealer about the proper class and type of hitch you need to purchase for your individual tow vehicle/RV combination. A FW requires a pin box hitch bolted directly to the floor of the truck box through the frame. Before selecting a hitch, you must know your GVWR and pin box rating. The factory installed FW pin box is not interchangeable.

**Fifth wheel pin box height**

There is no recommended hitch height for fifth wheels; usually the FW pin box is adjustable for variance in trucks and truck suspension systems. Adjust the hitch assembly so the tow

**WARNING**

**NEVER** use the breakaway switch and trailer brake system as a parking brake. Doing so would create a high amp draw on the battery and converter. This can cause non-warranty damage to wiring, connectors and the breakaway switch.



Do not remove the following label affixed to the pin box:

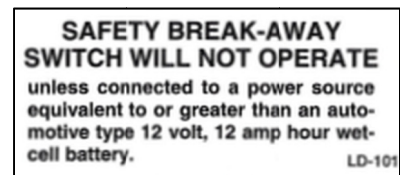

**WARNING**

The rating of the hitch package purchased should be equal to or greater than the RV's GVWR and pin box rating.

**WARNING**

Never allow anyone to go under the RV while it is being lifted and/or being towed.

vehicle and the FW are essentially level. A high hitch will transfer weight behind the axles and cause the vehicle to fishtail. A low hitch will transfer additional weight to the hitch. Refer to the hitch manufacturer instructions to adjust the weight distributing hitch to the proper height.

### **FW Hitching Procedure**

Hooking up a FW will become easier with practice. The following procedure will help until you become more experienced.

1. Make sure the trailer wheels are blocked.
2. Make sure the hitch lever is in its open or “cocked” position unless it has been designed to open automatically. Adjust the FW pin to the proper height. Lower the tailgate, if applicable.
3. Back the truck so the hitch encircles the FW pin.
4. A gentle contact of the hitch saddle against the pin will cause the mechanism to close.
5. Secure the hitch lever as specified by the manufacturer. Put the truck in drive (DO NOT press on the accelerator) and ‘bump’ the hitch to make sure it is locked.
6. Be sure to raise the FW landing legs all the way up.
7. Attach the breakaway switch cable to the tow vehicle.
8. Plug the wire harness/connector plug from the tow vehicle to the FW.
9. Remove the wheel chocks from the trailer wheels.

### **Towing**

You will find that your RV will travel safely and comfortably at most posted trailer highway speed limits. However, it will take longer than a passenger automobile to reach that speed. Keep this in mind when overtaking and passing another vehicle. Allow more time to go around the vehicle you are passing. You cannot cut back into the traffic lane as quickly due to the longer length of your tow vehicle/RV combination. Drive with caution to avoid situations that might require quick momentum changes.

Even though your RV is equipped with brakes designed for GVWR, we suggest practicing stopping away from traffic until you become accustomed to your RV’s stopping distance. A good way to practice is at a large parking lot (where it is permissible). Easing to a stop and starting smoothly saves wear and tear on your tow vehicle/RV combination.

Be aware of road surface conditions. Slow down well in advance of dips and bumps to reduce the jolting to your tow vehicle/RV combination. Drive over them slowly and let the trailer tires pass over them before accelerating. Cross railroad tracks slowly (always release your brakes before crossing).

When descending a long hill, drop down into a lower gear (or lower range if you have automatic transmission). Avoid conditions that require excessive and prolonged use of your brakes. Apply and release brakes at short intervals to give them chance to cool. The tow vehicle transmission and engine will help in controlling downhill speed and can lengthen brake life.

The distance required to stop the RV is greater than an automobile's. Use care when accelerating or decelerating on a slippery surface. Abrupt speed changes can cause skidding and loss of control. Driving through water deep enough to wet the brakes may affect stopping distance or cause the vehicle to pull to one side. Check the RV's brake operation in a safe area to be sure they have not been affected. Never operate any vehicle if a difference in braking efficiency is noticeable.

#### Vehicle Clearance

Remember some bridges, older ones in particular, may not support the weight of your tow vehicle/RV combination. Know the weight and size of your towing combination and observe any posted weight and clearance limits. The added height of roof air conditioners, TV antennas or floodlights may cause clearance problems around some tunnels, canopies and hanging signs.

#### Turning Corners

When turning, the tires do not follow the path of your tow vehicle tires. The RV will make a tighter turn than the tow vehicle. You must compensate for this action by carefully pulling the tow vehicle out into the intersection further than you would normally so that the RV clears the curb (or any parked vehicles along the curb).

#### Backing up

If your camping destination does not have pull through sites, pick a level site and back in carefully. We suggest you stop near the site, get out of the RV and observe the surrounding area

Check to ensure there are no obstacles in your path and that you have plenty of vehicle clearance. Check for low-hanging tree limbs, posts, large rocks or other obstacles. Try to choose a site that is on the driver's side, so you can see what the rear of the RV is doing. With the site on the passenger side, you would be backing into the site on your blind side, which is more difficult. When you determine the site conditions are satisfactory, maneuver the RV into position for backing up into the site space. Back the RV up slowly using your tow vehicle mirrors as a guide. Have another person outside the RV assist you until the RV is parked in the desired position.

### **WARNING**

*When making a turn, check the road clearance and be aware of others. Have someone help guide you out of a difficult parking space or traffic pattern. Swerves and sharp turns, especially at high speeds, could result in loss of control of the RV.*

### **WARNING**

*Towing items behind RV, or overloading the rear, will void the warranty and may result in: damage to the RV or add-on items, towing difficulties, property damage and/or personal injury.*

## NOTICE

**Ensure that the trailer is level before operating the slideout room.** Water leaks and other problems could result if the slideout is operated without leveling the trailer.

## WARNING

The FW landing legs must be fully retracted before moving or towing the RV to prevent damage.

## WARNING

**DO NOT USE THE FW LANDING LEGS TO SUPPORT THE TOW VEHICLE WEIGHT.** The FW landing legs are designed to bear the front loaded weight of the RV only.

### Parking

After the RV is in the desired location, set the tow vehicle parking brake and place the transmission in park. Turn OFF the ignition switch. Go outside the RV and block all wheels securely with wheel chocks. The wheel chocks can be wood blocks or purchased items as long as they prevent the RV from rolling.

### Passenger Safety

Passengers should never be allowed to travel inside your RV while in transit. Several states have very specific laws prohibiting this practice.

### FW Setup

1. Pull into the site, and park the RV where you want it.
2. Block the wheels securely to prevent the RV from moving.
3. Drop the landing legs (important!) Refer to the operator's manual for proper operation.
4. Disconnect the wire harness/connector plug and breakaway switch lanyard.
5. Drop the truck tailgate (unless you have a tailgate specially designed to accommodate a FW hitch).
6. Gently put your truck into reverse (don't give it any fuel/acceleration). This effectively moves the kingpin off the locking bar that will allow you to disengage it.
7. Step on brake and apply parking brake.
8. Disengage the locking bar and unhitch.
9. Drive away.
10. Adjust the fifth-wheel height for proper front to back leveling of the RV.

### Leveling the RV

Now that you have parked your RV, you need to ensure it is level. Leveling is very important. A level RV is more comfortable for sleeping and walking inside. The refrigerator is designed to operate when level for best performance due to the absorption system. The water drainage systems are designed with proper slope and must be level for proper operation. The appliances perform best when level.

### Before operating the hydraulic leveling system make sure:

1. The RV is parked on a reasonably level surface.
2. The towing vehicle is disengaged from the RV.
3. Make sure all persons, pets and property are clear of the RV while the leveling system is in operation.

To operating the hydraulic leveling system, read and following the instructions printed on the component manufacturer's instruction labels. Do not remove these labels from the inside of the front, off-door side (ODS) compartment door:

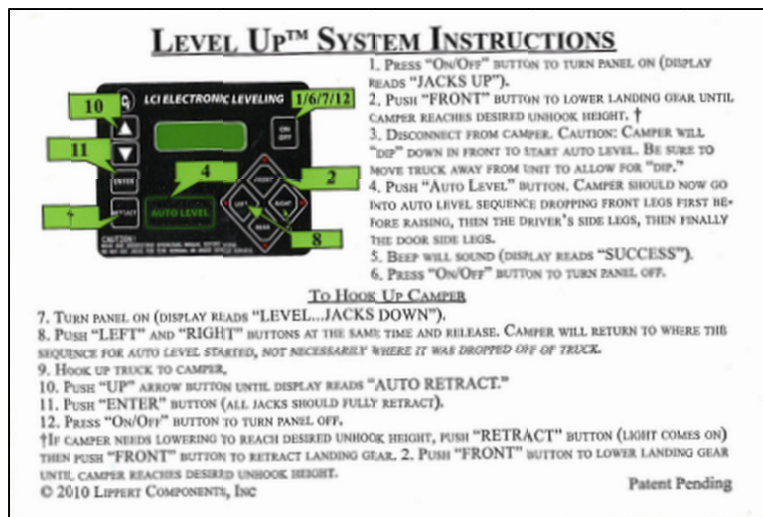

Typical Level Up System Instructions label

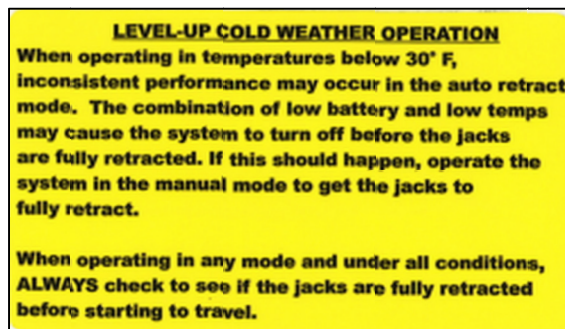

Typical Level-Up Cold Weather Operation label

### Maintenance

1. Retract the leveling legs to check the fluid level every month. The fluid should be within  $\frac{1}{4}$ " of the fill spout lip.
2. As needed, always fill the reservoir with the leveling legs in the fully retracted position. Filling the reservoir when the legs are extended will cause the reservoir to overflow into its compartment when the legs are retracted.
3. Inspect and clean all pump unit electrical connections every 12 months.
4. Remove dirt and road debris from the leveling gear as needed.
5. If the leveling legs are in the extended position for extended periods, it is recommended to spray the exposed landing gear rod with a silicone lubricant every seven (7) days for protection. If your RV is located in a salty environment, it is recommended to spray the rods every 2 to 3 weeks.

### Overriding the hydraulic landing legs/leveling legs

There are two options when overriding the hydraulic leveling legs. The instructions for both options reference the override valves labeled in the photos on the next page.

## **NOTICE**

*For optimum performance, the Level-Up hydraulic system requires a fully charged RV auxiliary battery be properly connected to the RV. Failure to do so will result in non-warranty damage.*

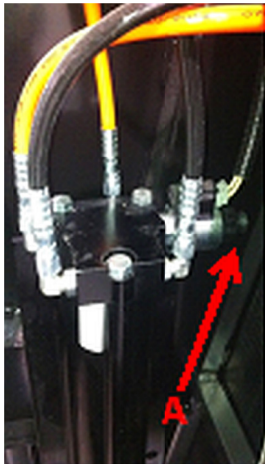

Typical hydraulic front landing legs override valve, generally located in the front, door-side compartment.

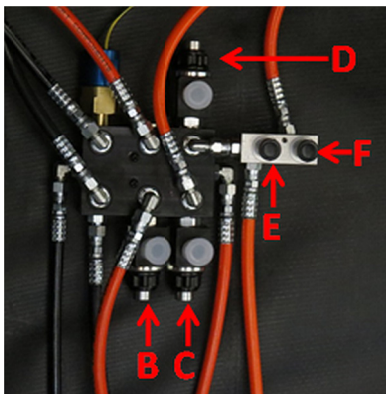

Typical hydraulic slide rooms and leveling legs override valves, generally located in the front facing compartment.

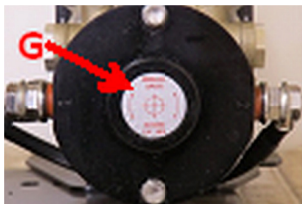

Typical protective seal, located on the end of the motor attached to the hydraulic reservoir.

Valve	Description*	Typical location
A	Extend/retract the front landing legs	Front, DS comp
B	Extend/retract the DS leveling legs	Front facing comp
C	Extend/retract the ODS leveling legs	Front facing comp
D	Open/close the slide room valve block (which houses valves E & F)	Front facing comp
E	Extend/retract the hydraulic DS slide room	Front facing comp
F	Extend/retract the hydraulic ODS slide room	Front facing comp

\*DS = door-side, ODS = off-door side, comp = compartment

- Rotating a hydraulic system override valve clockwise will open it.
- Rotating a hydraulic system override valve counterclockwise will close it.

Option 1 – using the “Slide Room 1” button

1. Make sure valve D is open. To open valve D, insert a 5/32” allen wrench into the manual override and rotate it 1.5 to 2 turns clockwise.
2. Extend or retract the appropriate slide room by opening or closing valves E and F.
3. Open valves B and C by inserting a 5/32” allen wrench into the manual override and rotating it 1.5 to 2 turns clockwise.
4. Extend or retract the leveling legs as needed by pressing the “Slide Room 1” button, located in the Command Center.
5. When the leveling legs are in the desired position, close valves B and C by inserting a 5/32” allen wrench into the manual override and rotating it 1.5 to 2 turns counterclockwise until snug. Do not over tighten!
6. Open valve A by inserting a 5/32” allen wrench into the manual override and rotating it 1.5 to 2 turns clockwise.
7. Extend or retract the landing legs to the desired position using the “Slide Room 1” button, located in the Command Center.
8. Close valve A by inserting a 5/32 allen wrench into the manual override and rotating it 1.5 to 2 turns counterclockwise until snug. Do not over tighten!

Option 2 – in the event the pump is in operable

1. Make sure valve D is open. To open valve D, insert a 5/32” allen wrench into the manual override and rotate it 1.5 to 2 turns clockwise.
2. Open valves B and C by inserting a 5/32” allen wrench into the manual override and rotating it 1.5 to 2 turns clockwise.
3. Peel off the protective seal located on the end of the motor that is attached to the hydraulic reservoir.

4. Attach a ¼" hex head bit to your hand drill (customer supplied), and insert it into coupler G (previously hidden under the protective seal). Run the drill clockwise to extend the level-up jacks and counter-clockwise to retract them.
5. When the leveling legs are in the desired position, close valves B and C by inserting a 5/32" allen wrench into the manual override and rotating it 1.5 to 2 turns counter-clockwise until snug. Do not over tighten!
6. Open valve A by inserting a 5/32" allen wrench into the manual override and rotating it 1.5 to 2 turns clockwise.
7. Extend or retract the landing legs to the desired position using coupler G.
8. Close valve A by inserting a 5/32 allen wrench into the manual override and rotating it 1.5 to 2 turns counterclockwise until snug. Do not over tighten!

This page is intentionally blank



## **Electrical Systems**

The RV electrical system is comprised of two independent electrical systems. One operates off of 12-volt DC power and the other off of 120-volt 60hz AC power. All installations have been made in compliance with industry standards applicable on the date of manufacture. Because the electrical equipment and associated circuitry are engineered into a dedicated system specific to your RV, we recommend you do not make unauthorized changes or add fixed appliances to it. Changes or additions made after delivery may result in a hazardous condition.

Service and/or modification of the electrical system should only be performed by qualified electrical technicians using approved materials, components, and methods meeting current safety and code requirements. Please consult your dealer's service department for assistance. To read more about the various components incorporated into the RV electrical system, please refer to the information contained in your Owner's Information Package.

### **Electrical System Maintenance**

Always disconnect the shore power cord and disconnect the negative 12-volt DC battery terminal before working on the electrical system. Always make sure the power converter, is turned "off" before disconnecting the battery.

### **120-Volt AC System**

The following electrical components (if so equipped) will only operate when your RV is connected to shore power: 120 to 12-volt power converter, air conditioner, 120-volt refrigerator, microwave oven, television(s), fireplace and appliances plugged into convenience receptacles.

Your RV is equipped with a 50 amp 120-volt 60hz AC electrical system. The entire system is designed to operate on 2 legs of 120-volt power at a maximum current flow of 50 amperes per leg. Exposure to voltages higher or lower than a nominal 120-volts will damage or shorten the service life of the electrical system and appliances. The 50 amp 120-volt 60hz AC electrical system can be powered by the 120-volt 60hz utilities found in RV campgrounds or by 120-volt 60hz generator power.

### **120-Volt Circuit Breakers**

The 120-volt AC circuit breakers located inside the main load center protect all 120-volt wiring and components in the RV from circuit overloads and short circuits. Should a circuit overload or short circuit occur the circuit breaker protecting the

#### **WARNING**

*Use caution when using metal tools. If a tool contacts a battery terminal or metal connected to it, a short circuit could occur which could cause personal injury, explosion or fire*

#### **WARNING**

*Make very certain the external power source (50 amp systems only) you connect the power cord to is a **50 amp NEMA 14-50 RV receptacle** and not 240 volt AC.*

## **⚠ CAUTION**

*Circuit breakers and fuses will not offer complete protection of the electrical system in the event of power surge or voltage spike.*

## **⚠ WARNING**

*Replacement circuit breakers must be of the same voltage, amperage rating and type. Never use a higher rated replacement circuit breaker; doing so may cause a fire by overheating the RV wiring.*

## **⚠ WARNING**

**PLUG INTO 50-AMP SERVICE ONLY.**

## **⚠ WARNING**

*The power cord must be fully extended when in use and not left coiled in the electrical compartment or on the ground. If the power cord is left coiled, it may potentially create enough heat to melt its protective casing.*

affected circuit will “trip” preventing the flow of electricity through that circuit.

If a circuit breaker trips, shut “off” the appliance on that circuit (i.e., power converter etc.) and allow the circuit breaker to cool down for a brief period of time. After the cooling down period, reset the circuit breaker by moving its lever “off” and then back to the “on” position. If the circuit breaker re-trips or frequently trips, contact your dealer to have the electrical problem diagnosed and repaired.

### *Maintenance and Replacement*

A circuit breaker identification label is permanently attached to the inside surface of the 120-volt load center. At the beginning of camping season, inspect the circuit breakers and replace as needed. Test by turning each circuit breaker “off” and back “on”. Circuit breakers are wearable parts and must be replaced as needed, as part of your RV maintenance. If you have any questions, consult your dealer.

### **50-Amp Power Cord**

The power cord is also commonly referred to as the “shore power cord.” This power cord is designed to ground the RV electrical system through the external power source receptacle. It is also designed to carry the voltage and current output from campground power receptacles.

Occasionally the electrical service provided by a campground may experience low or high voltage (i.e., surges or spikes). Any prolonged exposure will shorten the life of the electrical system and appliances. Consult your dealer for recommendations on power surge protection.

### *Connecting the power cord*

Always test the external power source (i.e., the campsite power receptacle or electrical box) with a ground monitor before connecting your power cord to it. If the ground monitor indicates 'reverse polarity' or an 'open ground' DO NOT connect the power cord.

1. Turn “off” the load center main 120-volt circuit breaker.
2. Carefully extend the entire length of the power cord from the electric cable hatch to the external power source.
3. Plug the power cord into the receptacle. Be sure all the power cord prongs are properly plugged into the receptacle.
4. Return to your RV and turn “on” the load center main circuit breaker.
5. To help prevent power surges from damaging the connected loads, please follow these instructions when hooking up to the external power source.

The shore line power cord should be unplugged when the RV is left unattended. If something would happen to the electrical system, this may help limit potential damage.

When you are ready to leave, reverse the power cord connection process. Use care to prevent damaging the power cord electrical connection pins when connecting or disconnecting the shore line power cord. Grasp the plug to remove the power cord from the outlet; do not unplug it by pulling on the cord.

### *Maintenance*

Inspect the power cord for cuts, cracks and worn insulation. Have the power cord replaced immediately if these symptoms are noticed.

### **Converter**

The power converter converts 120-volt AC power to useable 12-volt DC power when the shore power cord is connected to an external power source. The converter has a built-in protective thermal breaker that will shut it down should overheating occur. Overheating can be caused by operating the converter above its maximum power output for an extended period of time, or by an obstruction to its ventilation air flow. To reduce converter heat build keep unnecessary 12-volt lights and motors turned "off". Keep the converter cooling fins and fan clear of obstructions.

### *Inspection and maintenance*

If the 12-volt power converter is not working (auxiliary battery not being charged) check the reverse polarity fuse(s) in the converter fuse panel. There are no customer serviceable parts inside the converter case and the manufacturer's warranty will be void if the case has been removed. If you have further concerns contact your dealer.

### **GFCI Receptacle**

Grounding is your personal protection from electrical shock. Each RV has a ground fault current interrupter (GFCI) engineered into the electrical system. This device has been designed to reduce the possible injury caused by electric shock. The GFCI will not protect against short circuits or circuit overloads.

Contact your independent dealer for assistance if the GFCI "RESET" button does not restore 120-volt power and pops back out.

A "tripped" GFCI receptacle indicates that abnormally high 120-volt current flow (a ground fault) was detected through the

## **⚠️ WARNING**

- *Do not hook up the power cord to any receptacle until you have verified proper polarity and grounding. Polarity indicators can be purchased in most electrical and hardware stores.*
- *Do not use any cheater plug, adapter or extension cord to reconfigure incoming AC power or break the continuity of the circuit connected to the grounding pin.*
- *Do not connect the power cord into an outlet that is not grounded, or adapt the power cord plug to connect it to a receptacle for which it is not designed.*
- *Do not remove the grounding pin to connect to a non-grounded receptacle. Removal of the ground pin disables an important safety feature designed to prevent shock and electrocution hazards.*
- *Do not connect the power cord to an extension cord. Use of an improper extension cord will cause overheating of the cord as well as potentially causing premature failure of the AC equipment.*

*It is the responsibility of the owner of the electrical receptacle to ensure that the receptacle is properly wired and grounded. Reverse polarity and/or improper grounding of your RV can cause personal injury or death.*

electrical system grounding circuit. A fault condition can be caused by faulty wire insulation, wet wiring inside an appliance, or faulty electrical equipment connected to the circuit, etc. All ground faults must be repaired before use of the RV.

Test all GFCI receptacles monthly

- Push in the GFCI “TEST” button. The GFCI “RESET” button should pop out indicating the GFCI receptacle has been “tripped” and interrupted 120-volt power.
- Push in the GFCI “RESET” button to restore 120-volt power. Contact your dealer for assistance if the GFCI “RESET” button does not restore 120-volt power and pops back out.

### **Calculating Electrical Load**

When connecting appliances to the electrical system, remember that 120-volt power usage is limited to a total of 100 amps. Be mindful of the fact that each operating appliance collectively places an added load on your 120-volt electrical system.

An unintentional “trip” of a circuit breaker may occur if you overload the RV’s and/or campgrounds electrical system. The amperage rating of individual appliances can be calculated by dividing appliance wattage consumed (normally listed on the appliance) by nominal design voltage (120 for a 120-volt appliance). For example: 1200 watts divided by 120-volts equals 10 amps.

### **Mini-EMS**

Your unit has a 120-volt Mini-EMS (energy management system) designed to monitor the total AC current of an RV and assist to prevent circuit breaker tripping by momentarily shedding up to four loads (the four loads and shed priority are listed below):

1. AC Zone 1 Main floor living room area
2. AC Zone 2 Front bedroom area
3. AC Zone 3 Garage area
4. Washer/dryer

The Mini-EMS is designed to help owners, who are used to 50-amp service, deal with the common situation of campgrounds where only 30-amp service is available. The system monitors the current electrical draw for the entire RV including owner added loads, it learns controlled appliance current draw, and it allows two air conditioners to run on 30-amp service when other appliances are not in use. The I/O module has built-in 120-volt AC sense circuitry so it knows when shore power is available (and does not draw on battery power when dry camping).

For example, if you turn on additional appliances such as a microwave, coffee pot or hair dryer, the Mini-PCS can shed two 120-volt AC appliances such as the refrigerator and water heater, then if additional reduction in power is required the second air conditioner and lastly the first air conditioner is shed. As appliances are turned ON, the Mini-EMS will automatically turn power back on to each of the shed loads in reverse sequence.

The Mini-PCS, when turned ON, continuously monitors the RV's 120-volt AC power, and sheds and restores power to the four controlled loads.

#### *Mini-EMS operation*

Press the SELECT button on the Mini-EMS control panel to choose the electrical service listed below:

**30A (30-amp service)** – the power control system (PCS) senses 0-volts AC between L1 and L2. The I/O Module has a current sensor which monitors the current on the neutral wire. When the current exceeds the 30-amp limit, because possibly the owner has turned on the microwave, the PCS will limit the current by shedding appliances. Once the total RV current has dropped, for example because an owner operated appliance has been turned off, the PCS will reverse the previous procedure, returning power to appliances whose operation is not immediately critical.

**20A (20-amp service)** – the PCS senses 0-volts AC between L1 and L2, and the owner selects 20A on the remote display. The PCS performs the same functions as described above, except that it limits total current to 20-amperes.

**GEN (generator)** – the PCS senses power to the generator hour meter. In this mode, the PCS assumes enough power is available and goes to sleep. It displays the fact that the gen-set (generator set) is running, and that all loads are powered.

**50A (50-amp service)** – the PCS senses 240-volt AC between L1 and L2 to determine this mode of operation. In this mode the PCS assumes enough power is available and goes to sleep. It displays the fact that 50-amp service is available and that all loads are powered.

For additional information, we have included a general Mini-EMS diagram on the next page showing a typical mini power control system (PCS) layout.

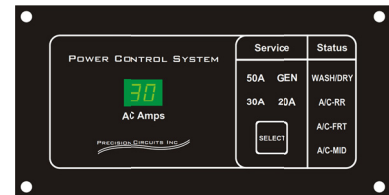

*Typical Mini-EMS control panel*

Diagram shows the typical layout for the Mini-EMS

# MINI POWER CONTROL SYSTEM



## Momentum by Grand Design WIRING DIAGRAM 06-11-2013

Exact Location of Breakers not Critical  
As long as Washer Dryer & A/C-RR are on  
opposite phases of Line Voltage.

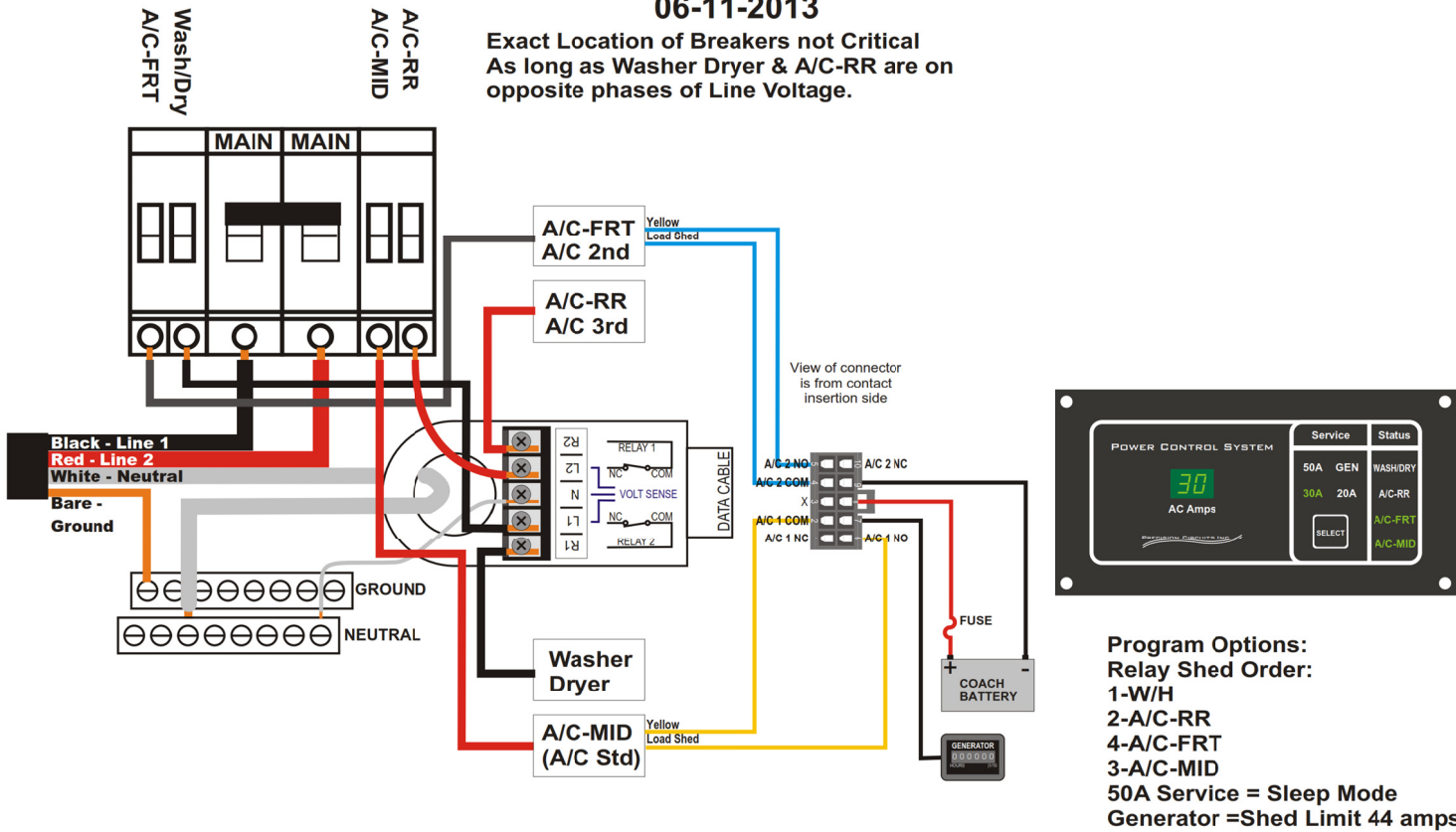

## **12-Volt DC System**

The majority of your RV lighting is powered by 12-volt electricity. The 12-volt DC system is composed of components that will operate when the following conditions are met:

- Power is supplied by the tow vehicle alternator when the engine is running and the 7-way trailer plug is connected. This powers the RV's running lights, brake lights, turn signals and brakes. In addition, the 7-way trailer plug provides a common ground and a 12-volt charge line to charge the auxiliary battery.
- The converter will supply interior 12-volt DC power when the power cord is plugged into campground power. The converter will also charge the RV battery in most situations.
- The auxiliary battery powers many interior 12-volt components including the lighting fixtures, water pump, 12-volt motors, 12-volt appliances, etc. It also powers the breakaway switch.

## **Battery Disconnect Switch**

There is a master battery disconnect switch (see photo) located in the large, front pass-thru compartment. When the RV is not in use or storage, shut the battery disconnect switch off and disconnect one of the battery cables from the auxiliary battery terminal. Remember to reconnect the battery cable and turn the battery disconnect switch on when you are ready to use the RV or perform periodic maintenance checkups.

## **Auxiliary Battery**

Your RV has many 12-volt DC loads. When combined, their total is more than the converter can produce. High demands for 12-volt power can be met by an auxiliary battery for limited periods of time. The 12-volt DC electrical system is designed for usage with a Group 27, deep cycle battery.

### *Dry camping*

Consider the charge condition of the auxiliary battery when dry camping. If the auxiliary battery is not being recharged and power is being drawn from it, it will eventually discharge. A battery will discharge at a faster rate as its energy level becomes depleted. It is recommended you plan your electrical usage accordingly. For accuracy, test the auxiliary battery voltage using a volt-ohm meter.

A fully charged auxiliary battery will read 12.7 volts DC and 1.265 specific gravity at 80°F (32°C). The auxiliary battery is considered discharged at 11.8 volts, and dead at 11.65 volts. When voltage drops below those levels, permanent damage

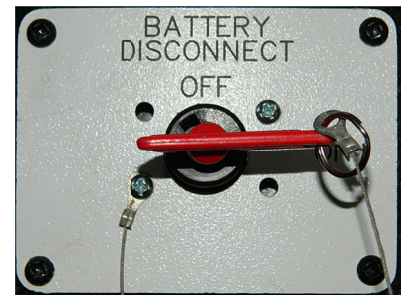

*Typical battery disconnect switch*

## **WARNING**

*Replacement fuses must be of the same voltage, amperage rating and type. Never use a higher rated replacement fuse; doing so may cause a fire by overheating the RV wiring.*

may occur. Typically, a deep cycle battery has an amp-hour rating of 75-100 amps.

If the furnace and refrigerator are operating simultaneously, approximately (12.0 + 3.0) 15.0 amps per hour are used. This does not include any 12-volt lights, water pump or any other 12-volt component.

If the furnace and refrigerator in the above example operated constantly, a 75 amp-hour battery would become fully discharged in 5 hours (75ah /15a = 5h).

The auxiliary battery should be installed in parallel with the battery in your tow vehicle. When the 7-way trailer plug is connected, both batteries power the RV so it is important not to discharge your tow vehicle battery below the level required to start the engine. To prevent this from occurring, disconnect the 7-way trailer plug or install a battery isolator. When the tow vehicle engine is operating with the RV connected, the tow vehicle charging system will charge both batteries.

### *Replacement and maintenance*

Some equipment in your RV will draw small amounts of current even when turned OFF. To prevent the auxiliary battery from being discharged when your RV is not connected to shore line power, disconnect the auxiliary battery negative cable at the battery. During storage, it is important to check the voltage monthly and recharge the auxiliary battery as needed. If you remove the auxiliary battery from your RV, store it in a dry, cool area per the manufacturer's instructions.

When it is time to replace the auxiliary battery, replace it with a Group 27 deep cycle battery only. Contact the battery manufacturer for further information. Do not reverse the positive and negative battery cables (doing so will blow the reverse polarity fuse(s) that protect the converter).

### **12-Volt Fuse Panel**

The 12-volt fuse panel is labeled to indicate fuse sizes, positions and the components powered. At the beginning of camping season, inspect all the 12-volt fuses and replace as needed.

### *Replacing a fuse*

Before replacing a fuse, always turn off the electrical component(s) protected by it.

1. Disconnect the shore power cord.
2. Disconnect the RV auxiliary battery main negative battery cable.
3. Remove the fuse panel cover to check fuses.



4. Pull the fuse straight out of the fuse block. If the fuse is not blown, something else must be causing the problem. Please contact your dealer for further assistance.
5. Insert a new fuse of the same specified voltage, amperage rating and type in the original location. Never use a higher rated replacement fuse.

The fuse panel label should be kept permanently affixed to your RV. The fuses will not offer complete protection of the RV electrical system in the event of a power surge or spike.

### **12-Volt DC Outlet (If So Equipped)**

There may be a 12-volt DC outlet (not applicable on all models) in your RV. When the 12-volt DC outlet is used as a power source for an electric appliance, make sure that the appliance operates on 12-volt DC power and that it consumes less than 60 watts (5 amps) of 12-volt power. To prevent short circuits do not allow metallic foreign matter to get into the 12-volt DC outlet.

### **Generator (if so equipped)**

The factory-installed generator will produce 120-volt AC power for use when camping in areas where shore power is unavailable. It can be controlled both at the generator and at the remote START/STOP control located inside the RV at the Command Center. The power to start the generator comes from the auxiliary battery (customer supplied). Be aware the generator runs on gasoline and gives off carbon monoxide (see Occupant Safety).

**Hour meter** - Indicates total generator operating time in hours and tenths of hours. Use the hour meter with the generator maintenance schedule for periodic maintenance.

**START/STOP switch** - First, “prime” the motor by pressing the switch in the STOP/PRIME position. HOLD until the light stops flashing. The motor is now primed. To start the generator, press and hold at the RUN position. Release the switch when the engine starts (the GEN RUN lamp will come on). To stop the generator, hold the switch at the STOP position until the engine stops.

*Every time before starting the generator:*

- Check the fuel level in the fuel tank.
- Check the oil level.
- Check all fuel lines for fuel leaks.
- Inspect generator for loose or damaged components and fasteners.
- Inspect the generator exhaust system for damage or leaks.

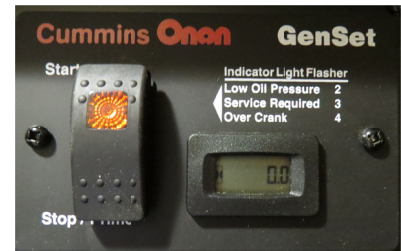

*Typical generator remote START/STOP control, located inside the Command Center.*

### **⚠ WARNING**

*The generator produces carbon monoxide while it is running. Carbon monoxide is a colorless, tasteless, odorless gas. CARBON MONOXIDE IS DEADLY. Test the carbon monoxide detector every time you use the RV (see Occupant Safety). **BE SURE TO READ AND UNDERSTAND THE GENERATOR MANUFACTURER OPERATOR'S MANUAL BEFORE OPERATING THE GENERATOR.***

### **⚠ WARNING**

***DO NOT under any circumstances operate the generator while you are sleeping.** You would not be able to monitor outside conditions to assure that engine exhaust gases are being safely dissipated and are not entering the RV interior. You would not be alert to exhaust odors or the symptoms of carbon monoxide poisoning (see Occupant Safety).*

## **⚠️ WARNING**

*Do not block the generator ventilating air inlets or outlets. Restricting the ventilating air inlets or outlets can cause engine failure or fire from engine overheating*

## **⚠️ WARNING**

*Do not place flammable material or store any other materials in the generator compartment. Heat from the generator or generator exhaust may cause this material to ignite.*

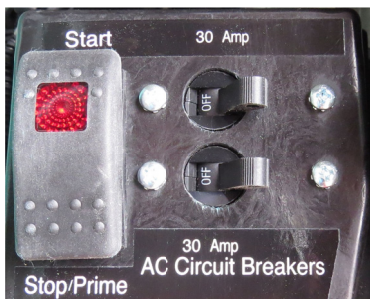

*The output from the generator may be interrupted if the main generator circuit breakers trip. These breakers are located on the main generator control panel (remove the cover on the generator to access). If there is no power when the generator is running, check and reset these breakers.*

- Test the carbon monoxide detector every time you use the RV (see Occupant Safety).
- Correct any problems before operating the generator.

### *Additional operating safety precautions and warnings*

- DO NOT operate the generator in an enclosed building or in a partly enclosed area such as a garage.
- DO NOT operate the generator if exhaust gases cannot be discharged away from the RV or other vehicles.
- Do not block the exhaust pipe. Do not park the RV where the exhaust gases can accumulate either outside, underneath or inside the RV or other vehicles.
- Make sure exhaust gases are clear of walls, snow banks or any obstructions that can prevent exhaust gases from dissipating.
- DO NOT operate the generator when the RV is parked in high grass or brush. Heat from the exhaust could cause a fire in dry conditions.
- DO NOT operate the generator when parked in close proximity to vegetation, snow, buildings, vehicles, or any other object could deflect the exhaust under or into the vehicle.
- DO NOT simultaneously operate the generator and a powered ventilator which could result in the entry of exhaust gas. When exhaust ventilators are used, open a window on the opposite side of the RV upwind of exhaust gases to provide cross ventilation. When parked, position the RV so that the wind will carry the exhaust away from the RV.
- DO NOT open nearby windows, ventilators, or doors into the passenger compartment, especially those downwind, even part of the time. Never operate your tow vehicle or generator engine longer than necessary when parked.
- DO NOT fill the fuel tank while the generator is running. Fuel contact with the hot generator or exhaust is a fire hazard.
- DO NOT smoke or have an open flame near the generator or fuel tank.
- Never store anything in the generator compartment. Always keep the compartment clean and dry.
- DO NOT start the generator while a load is connected. Make sure the MAIN circuit breakers are OFF before starting.

### *Starting the generator*

- Set the main circuit breakers to OFF.
- Connect the shoreline power cord to the shore power receptacle.
- Press and hold the START/STOP switch in the STOP/PRIME position at either control panel until the red light stops

flashing; then hold the switch in the START position until the generator starts. The indicator light will remain on after the switch is released.

- If the generator does not start, release the switch. Wait two minutes and try again (priming first). If the second try does not start the generator, try starting using the START/STOP on the generator control panel. If the indicator light still does not light, there may be an open in the remote wiring. Contact a service center for assistance.
- Do not turn on the main breakers until the generator is running smoothly and is warmed up. Check that there are no fuel or exhaust leaks.
- Turn off the individual breakers, and set the main breakers ON. Turn on the individual circuit breakers one at a time to prevent generator overloading.
- To stop the generator, turn off the main breakers. Let the generator run three to five minutes to cool down. Press and hold the START/STOP switch to the STOP position until the generator stops completely and the indicator light goes out. If the switch is released before the generator stops and the light goes out, the generator will continue to run.

#### *Fuel varnishing*

If you store your RV over the winter, or do not operate it often enough to refuel the gas tank every month, a fuel varnishing problem could develop in your generator engine and fuel system. Fuel varnish is a gummy residue that clogs the generator carburetor and fuel pump, and is caused by the deterioration of fuel. Depending on fuel quality and storage conditions, gasoline can deteriorate in as little as 30 days. As long as you refuel frequently with fresh gasoline, and exercise the generator regularly, fuel varnishing is less likely to occur. But if you leave the same gasoline in the tank for several months, you're very likely to have problems.

The only way to prevent fuel varnishing is to add a fuel preservative to the fuel (gasoline) tank and to run the generator. For more information, see the generator manufacturer's operating and maintenance manual.

#### *Maintenance*

During long periods of in-operation, or if the engine does not reach operating temperature, moisture can condense in the engine making starting difficult and causing damage to the engine. Operate the generator with a 50% capacity load for two hours once a month. A long exercise period that allows normal operating temperatures is preferable to short periods. Read and follow the details of additional service and maintenance in the generator manufacturer's manual.

### **WARNING**

*Disconnect the generator from the battery before performing any generator maintenance.*

### **WARNING**

*DO NOT touch the generator while it is running, or immediately after turning it off. Heat from the generator can cause burns. Allow the generator to cool before attempting maintenance or service.*

*Generator prep (if so equipped)*

Generator prep means the RV has the basic wiring necessary for installation of an aftermarket generator (customer supplied). RV generators are built in compliance with specific codes and standards. Your RV is not designed to use generators other than those built specifically for RVs. When you are ready to purchase an aftermarket generator, please consult your dealer for purchasing and installation assistance.

**Replacing Light Bulbs**

Before replacing a bulb, be sure the light is off. Do not touch the glass part of the new bulb with your bare fingers. The skin oil left on the glass will evaporate when the bulb gets hot, the vapor will condense on the reflector and it will dim the surface. Replacement light bulbs must be of the type, voltage and wattage listed on the lamp fixture. Use of incorrectly sized bulbs can overload lam circuits and may create a fire hazard by overheating the fixture.

**Approximate Electrical Load Ratings**

Use actual amperage (or wattage divided by 120) of appliance being used whenever possible.

120 Volt System	
Air Conditioner	18 amps
Coffee Maker	6-12 amps
Converter (each)	8 amps
Curling Iron or Hair Dryer	10-14 amps
DVD System	3 amps
Microwave	12 amps
Refrigerator	6 amps
Satellite Receiver	2 amps
TV	2-4 amps
Vacuum Cleaner	8 amps
Washer/Dryer	12 amps
Water Heater	12 amps

120 Volts: Labeled watts divided by 120 = power consumed in amps.

12 Volt System	
Aisle Lights	1.0 amp
Baggage Compartment Lights	1.4 amps
Decorative Wall Lights	1.5 amps
Dinette Light	4.5 amps
Exterior Entertainment Center	5-7 amps
Fantastic Fan	1.5 amps
Fluorescent Double Lights -12"	2.0 amps
Fluorescent Double Lights -18"	2.5 amps
Furnace	12.0 amps
Generator Start	95.0 amps*
Halogen Light	1.7 amps
Illuminated Switch	.125 amp
Inverter	variable
Leveling System	95.0 amps*
LP Detector	.125 amp
Map Light	1.5 amps
Porch Light	1.5 amps
Power Awning	10.0 amps
Power Vent	5.0 amps
Refrigerator	3.0 amps
Shower Light	1.4 amps
Step Cover	10.0 amps
TV Plate/Antenna Booster	1.0 amp
Vanity Light	4.2 amps
Water Heater	6.0 amps
Water Pump	7.0 amps

\*Momentary Load

This page is intentionally blank

## **Fuel System**

Your RV may be equipped with factory-installed tanks that supply fuel to the fuel station and generator. For your protection and others, it is critical to understand the danger associated with fuel. Take time to become educated about the property of fuel and use it safely. If you spill fuel on the RV, clean it up immediately. Fuel can dull or soften paint and damage other surfaces. Use care when fueling your RV.



Typical fuel system, located on the exterior sidewall.

## **Fuel Station**

Read, understand and follow all safety information in the fuel station manufacturer's manual before operating the fuel station. If you need further assistance, consult with your dealer the Grand Design RV Customer Service. Do not remove the following labels from the fuel station area:

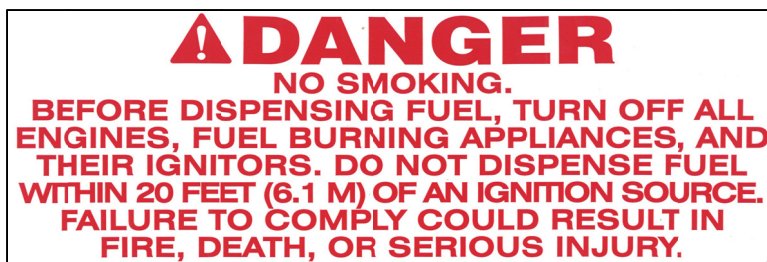

The RV is equipped with a master/emergency fuel pump disconnect switch located on the exterior of the fuel station. Make sure the switch is turned "OFF" when the fuel station is not in use.

### *To fill the fuel tanks:*

Before filling the RV fuel tanks(s), be sure the RV is level from side to side and front to back to avoid potential overfilling. DO NOT over fill the factory-installed fuel tank(s). Once the pump

## **! DANGER**

*Automotive fuels can cause serious injury or death if misused or mishandled. If you have further questions, consult your dealer or Grand Design RV Customer Service for assistance.*

- *Always shut OFF the tow vehicle engine while refueling.*
- *Do not bring or store fuel or other flammable liquids inside the RV because a fire or explosion may result.*
- *Before refueling, extinguish all smoking materials and any open flames.*
- *Before refueling, always turn OFF all spark producing appliances and their igniters and pilot lights (i.e., water heaters, furnaces, etc.).*
- *Do not overfill the fuel tank(s). The pressure in an overfilled fuel tank may cause leakage and lead to fuel spray and/or fire.*
- *Fuel spills represent a serious fire hazard, and should be cleaned up immediately.*
- *Never restart an engine or re-light any pilot lights while raw fuel is present.*
- *The fuel tanks are specifically made for unleaded gasoline. Use clean, fresh unleaded fuel not containing a blend of more than 15% Ethanol.*

**FAILURE TO COMPLY COULD RESULT IN FIRE, DEATH OR SERIOUS INJURY.**

## Fuel System



Typical fuel filler cap

### **WARNING**

Do not replace the fuel filler cap with one of a different type. If replacing the fuel cap(s) is required, it must be replaced with a cap designed specifically for this application. Failure to do so may result in improper vent pressure and/or vacuum leading to serious fuel system and other damage.

Working with fuel can be dangerous. Serious injury or death could result from improper handling of the generator, fuel station and fuel.



### **WARNING**

OPERATING PUMP FOR MORE THAN 5 MINUTES WITH NOZZLE CLOSED WILL REDUCE MOTOR LIFE

13706202

Do not remove this label from the fuel dispensing system emergency shut off switch hatch.

has shut off by itself, do not try to put more fuel in the tank. Overfilling the tank(s) may result in fuel leakage and damage to fuel system components. Follow all safety information in this manual and the OEM operator's manual. Failure to comply could result in death or serious injury

Typically, the fuel filler cap nearest to the front of the RV allows you to fill the generator fuel tank, and the fuel filler cap nearest the rear of the RV allows you to fill the pump fuel tank. The fuel tanks are specifically made for unleaded gasoline; use clean, fresh unleaded fuel not containing a blend of more than 15% Ethanol. The fuel tank(s) are not compatible with any other fuel blends or diesel fuel.

#### *Fuel filler cap*

Remove the fuel filler cap by slowly turning it counterclockwise and waiting for any "hiss" noise to stop. Then unscrew the cap all the way. Fuel can spray out on you if you open the fuel filler cap too quickly; this can happen if your tank is nearly full and is more likely to happen in hot weather.

To close the fuel filler cap, securely turn the cap clockwise until you hear clicking sounds. If you need to replace the fuel tank filler cap, use only a cap specified for your RV.

#### *To dispense fuel*

Be sure the fuel tank has fuel in it prior to operating the fuel pump. Ensure the fuel is not contaminated with debris.



Typical fuel dispensing system emergency shut off switch hatch

- Open the hatch, and turn the pump switch ON.  
*There is a five (5) minute safety timer that automatically shuts off the pump after five (5) minutes.*
- Open the compartment containing the fuel dispensing hose and nozzle then insert the nozzle into the receiving tank and squeeze the nozzle handle keeping the nozzle in contact with the tank fill opening of the vehicle or equipment being filled.



- When done, release the nozzle handle to stop the flow of fuel.
- Turn OFF the fuel station pump timer switch.

### Fuel gauge



Typical fuel gauge

Your RV is equipped with a fuel gauge to monitor the amount of fuel available for use. Press the rocker switch left to view the generator fuel tank information or press the rocker switch right to view the pump fuel tank information.

### Exhaust Gas Fumes

Avoid inhaling exhaust gases as they contain carbon monoxide, which is a potentially toxic gas that is colorless and odorless (see Occupant Safety).

- Always shut OFF the tow vehicle engine, generator engine (if applicable), etc., while refueling.
- Do not run the tow vehicle engine, generator engine (if applicable), etc., in confined areas, such as a closed garage, any longer than needed to move your RV in or out of the area.
- Windows should be closed while driving or running the generator (if so equipped) to avoid drawing dangerous exhaust gases into the RV.
- If you suspect that exhaust fumes are entering the RV have the cause determined and corrected as soon as possible.

## **WARNING**

*If you are in a RV with either a nearby tow vehicle engine running or the generator (if so equipped) running there is a potential for exhaust fumes to filter back into the RV.*

*The best protection against carbon monoxide entry into the RV is a properly maintained ventilation system and an active carbon monoxide detector. To allow for proper operation of the RV ventilation system, keep the ventilation inlet grill(s) clear of snow, leaves or other obstructions at all times.*

*See the Occupant Safety section of this manual for additional information on carbon monoxide safety.*

This page is intentionally blank

## **Propane System**

### **Propane Gas**

Propane is a colorless and odorless gas that, in the liquefied state, resembles water. Mercaptan, an odorant described by many people as having an odor similar to “rotten eggs,” is added as a warning agent. When a propane container is low, occasionally there may be a concentration of an onion or garlic-like odor, which can be mistaken for a propane gas leak. After the propane container has been refueled, the odor will usually disappear. If not, turn off the valve(s) and have the propane system inspected by your dealer or qualified propane service representative.

Propane or LP (liquefied petroleum) gas is a clean and efficient form of energy when proper handling and safety precautions are observed. The propane system in your RV furnishes the fuel for cooking, heating and hot water. Propane can also be used as an alternative energy source for refrigeration. The propane fuel system is comprised of numerous components such as the propane container, hoses, the propane gas regulator, piping and copper tubing lines to each appliance. Propane is heavier than air; the gas tends to flow to lower areas and will sometimes pocket in these low areas, such as the floor.

#### *Maintenance*

Although both Grand Design RV and your selling dealer carefully test for leakage, travel vibrations can loosen fittings. Have the propane system checked at all connections soon after the purchase of your RV, and after the initial filling of the propane tanks. Continued periodic checks of the propane system at 5,000 miles of travel (or at least once a year), by a qualified propane service representative as part of your normal maintenance is recommended.

### **Propane Leak Test**

Leaks may be found with a soapy water solution. Do not use a solution containing ammonia or chlorine when locating leaks. These products are corrosive to copper gas lines and brass fittings, which could result in deterioration of the copper and brass components. Apply the soapy solution to the outside of the gas piping fittings. If a leak is present, the soapy solution will “bubble” at the leak point. If a leak is indicated, shut off the propane system valve(s) and contact your dealer or a qualified propane service representative immediately.

### **Propane Alarm**

Please refer to the “Occupant Safety” section for information on



*Do not remove the following label from your RV. If you smell propane within the RV quickly and carefully perform the procedure listed:*

**⚠ DANGER**

**IF YOU SMELL PROPANE**

1. Extinguish any open flames, pilot lights and all smoking materials.
2. Do not touch electrical switches.
3. Shut off the propane supply at the container valve(s) or propane supply connection.
4. Open doors and other ventilating openings.
5. Leave the area until odor clears.
6. Have the propane system checked and leakage source corrected before using again.

**FAILURE TO COMPLY COULD RESULT IN EXPLOSION RESULTING IN DEATH OR SERIOUS INJURY. LD-101**

### **⚠ WARNING**

*Test the alarm operation after the RV has been in storage, before each trip and at least once per week during use.*

### **⚠ DANGER**

*Never use an open flame to test for a propane leak. Do not check for leaks using products that contain ammonia or chlorine; these products can cause cracks to form on the metal tubing and brass fittings.*

**⚠ WARNING**

Never turn the 12-volt battery disconnect control to the off position and disconnect the battery cable to silence the alarm.

**⚠ WARNING**

Propane cylinders should not be placed or stored inside RV. LP gas cylinders are equipped with safety devices that relieve pressure by discharging gas into the atmosphere.

**⚠ WARNING**

Before entering a propane or fuel service station make sure all pilot lights are extinguished. Shut off gas to all appliances by closing the propane gas main shut off valve. Always shut OFF any engine before refueling. Do not smoke and do not operate other ignition sources while refueling.



If so equipped, do not remove the following label from your RV:



this alarm; also read and follow the component manufacturer instructions supplied in your Owner Information Package.

**Propane Gas Container**

Propane “container” is a general all inclusive term used to describe a vessel that is used for storage and delivery of propane gas. The most common of these are DOT (Department of Transportation) cylinders that are transportable and commonly used on RV trailers. The capacity of DOT propane cylinders (also referred to as an LP bottle) is expressed in pounds. DOT propane cylinders are required to be removed from the RV for filling and must be filled by weight by a qualified propane facility. The cylinders are equipped with an OPD or over fill protection device designed to reduce the potential of overfilling. They are also equipped with an ACME service valve that is for connection of the TYPE 1 ACME pigtail hose assembly to the RV two-stage regulator.

The TYPE 1 ACME pigtail hose assembly is a wrench-less, user friendly, right hand threaded connector that features a thermally sensitive sleeve and excess flow device. Max output is 200,000 BTU/hr. It is used to connect propane cylinders to regulators, hoses and other fittings. It is not for use on gas grills and other low pressure devices. DOT cylinders equipped with an OPD and ACME type 1 service valve are identified by the triangular service valve knob.

DOT cylinders are typically marked with “top” or an arrow to indicate the correct orientation of the cylinder(s). Do not mount, store or transport any cylinder other than the in proper position indicated. Be sure to securely re-install DOT cylinder(s) to the RV after they have been removed for filling or replacement. Always close the service valve and install a dust cap or plug when transporting or storing disconnected containers whether full or empty.

Propane is a true gas compressed into a liquid form. As the fuel is released from the container, it changes to vapor which is then used for the operation of the appliances. Propane will not run through the appliances in the liquid state. Propane expands 1½ percent for every ten degrees of increase in temperature. It is imperative to leave sufficient space inside the container to allow for natural expansion of gas during warmer weather.

The main shut off valve must be kept closed at all times unless you are using the propane system or filling the propane cylinder. When the cylinder is disconnected from the hose, install the valve cover that is attached to the container. Close the propane cylinder main shut off valve by hand tightening

only. Use of tools creates a potential to over tighten the valve (damaging the interior seals on the cylinder valve seat). If this type of damage occurs, the cylinder will not close properly.

#### *Servicing or filling*

Have the RV checked for leaks at the connections on the propane system soon after the purchase and the initial filling of each propane cylinder. When you have a new cylinder filled for the first time, make sure your propane supplier purges your new cylinder of trapped air. Otherwise, an improper mixture of gas and air will make it impossible to light your propane appliances.

No one should be inside and only the qualified propane service technician should be near the RV while the propane tank is being filled. The new propane container must be carefully purged for best performance and must NEVER BE OVERFILLED. The position of the propane container(s) and the hoses are critical to proper operation and propane flow. Follow these instructions to make sure your propane container(s) are connected properly.

#### *LP gas container overfill*

Never allow your propane cylinder to be filled above the maximum safe level. Overfilling the propane container above the liquid capacity indicated on the container, could allow liquid propane to enter the system that is designed for vapor only creating a hazardous condition.

#### *Installing the propane cylinders*

1. Connect the 3/8" low-pressure hose to the outlet of the two-stage regulator.
2. Place the cylinder on the bracket in the recess compartment or housing and secure them so the outlets of the cylinder valves are facing the "sidewalls" of the compartment or housing (opposite of each other).
3. Mount the regulator on the center back wall of the compartment or housing so the vent is pointed downward.
4. Attach the 1/4" inverted flare x 18" Type-1 pigtail hose to the regulator inlet and the right hand swivel nut to the cylinder valve.
5. Attach the main supply hose from the regulator to the brass manifold fitting in the frame of the trailer. The swivel brass nut on the main hose will be your final attachment.



Do not remove the following two labels from your RV:

<b>⚠ DANGER</b>
ALL PILOT LIGHTS, APPLIANCES AND THEIR IGNITORS (SEE OPERATING INSTRUCTIONS) SHALL BE TURNED OFF BEFORE REFUELING OF FUEL TANKS AND/OR PROPANE CONTAINERS. FAILURE TO COMPLY COULD RESULT IN DEATH OR SERIOUS INJURY.
<b>⚠ WARNING</b>
DO NOT FILL PROPANE CONTAINER(S) TO MORE THAN 80 PERCENT OF CAPACITY. FAILURE TO COMPLY COULD RESULT IN A FIRE OR PERSONAL INJURY.
<b>⚠ CAUTION</b>
THIS PROPANE PIPING SYSTEM IS DESIGNED FOR USE WITH PROPANE ONLY. DO NOT CONNECT NATURAL GAS TO THIS SYSTEM. Securely cap inlet when not connected for use. After turning on propane, except after normal cylinder replacement, test propane piping and connections to appliances for leakage with soapy water or bubble solution. Do not use products that contain ammonia or chlorine. LD-101

<b>⚠ WARNING</b>
DO NOT FILL PROPANE CONTAINER(S) TO MORE THAN 80 PERCENT OF CAPACITY. FAILURE TO COMPLY COULD RESULT IN A FIRE OR PERSONAL INJURY. LD-102

**⚠ WARNING**

*If you suspect your propane container has been overfilled, contact your dealer or a qualified propane technician for assistance immediately. Do not attempt to service a propane container overfill yourself*

**⚠ WARNING**

*The pigtail hose must be installed to avoid tension or pulling stress at either end of the hose. Keep the pigtail hose away from sharp edges of the cylinder collar, rigid corners, walls, doors or other compartment structures including the cover.*

**⚠ WARNING**

*Ensure that all fasteners are secured before traveling.*

Do not remove the following label from your RV:

<p style="text-align: center;"><b>WARNING</b></p> <p style="text-align: center;">THIS SYSTEM IS DESIGNED FOR USE WITH PROPANE ONLY. DO NOT CONNECT NATURAL GAS TO THIS SYSTEM.</p> <p><b>BEFORE TURNING ON PROPANE:</b></p> <p>(A) BE CERTAIN APPLIANCES ARE CERTIFIED FOR PROPANE AND ARE EQUIPPED WITH CORRECT BURNER ORIFICES.</p> <p>(B) MAKE CERTAIN ALL PROPANE CONNECTIONS ARE TIGHT BY TESTING WITH SOAPY WATER. ALL APPLIANCE VALVES ARE TURNED OFF, AND ANY UNCONNECTED OUTLETS ARE CAPPED.</p> <p><b>AFTER TURNING ON PROPANE:</b></p> <p>(A) LIGHT ALL PILOTS.</p> <p>(B) ALL CONNECTIONS, INCLUDING THOSE AT THE APPLIANCES, REGULATORS, AND CYLINDERS, SHOULD BE LEAK-TESTED PERIODICALLY WITH SOAPY WATER BY THE OCCUPANT. NEVER USE A LIGHTED MATCH OR OTHER FLAME WHEN CHECKING FOR LEAKS.</p> <p>(C) DO NOT LEAVE SYSTEM TURNED ON OR CONTAINERS CONNECTED UNTIL THE SYSTEM HAS BEEN PROVEN TO BE FREE OF ANY LEAKS.</p> <p>(D) COOKING APPLIANCES SHOULD NOT BE USED FOR SPACE HEATING</p> <p>(E) WHEN THE CONTAINERS ARE DISCONNECTED, THE PROPANE SUPPLY LINE SHOULD BE CAPPED OR PLUGGED.</p> <p style="text-align: center;"><b>AVERTISSEMENT</b></p> <p style="text-align: center;">CETTE INSTALLATION EST CONÇUE POUR LE PROPANE SEULEMENT. NE PAS L'ALIMENTER EN GAZ NATUREL .</p> <p><b>AVANT LA MISE EN SERVICE:</b></p> <p>A) S'ASSURER QUE LES APPAREILS SONT CERTIFIÉS POUR LE PROPANE ET MUNIS D'ORIFICES DE BRÛLEUR APPROPRIÉS.</p> <p>B) VÉRIFIER L'ÉTANCHÉITÉ DE TOUS LES RACCORDEMENTS AU PROPANE, LA FERMETURE DE TOUS LES ROBINETS D'APPAREILS ET L'OBTURATION DE TOUTES LES SORTIES NON RACCORDEES.</p> <p><b>APRÈS LA MISE EN SERVICE:</b></p> <p>A) ALLUMER TOUTES LES VEILLEUSES.</p> <p>B) L'OCCUPANT DOIT ÉPROUVER PÉRIODIQUEMENT L'ÉTANCHÉITÉ DE TOUS LES RACCORDEMENTS, Y COMPRIS CEUX AUX APPAREILS, AUX DÉTENDEURS ET AUX BOUTEILLES, EN Y APPLIQUANT DE L'EAU SAVONNEUSE. NE JAMAIS SE SERVIR D'UNE ALLUMETTE OU AUTRES FLAMMES POUR LA DÉTECTION DES FUITES.</p> <p>C) NE PAS LAISSER L'ALIMENTATION OUVERTE, NI LES RÉCIPIENTS RACCORDES, AVANT D'AVOIR COMPLÉTÉ L'ÉPREUVE D'ÉTANCHÉITÉ AU PROPANE DE L'INSTALLATION.</p> <p>D) LES APPAREILS DE CUISSON NE DOIVENT PAS ÊTRE UTILISÉS POUR LE CHAUFFAGE DES LOGEUX.</p> <p>E) LORSQUE LES RÉCIPIENTS SONT DÉCONNECTÉS, L'ALIMENTATION DE PROPANE DOIT ÊTRE OBTURÉE OU SCELLÉE.</p> <p style="text-align: right;">LD-102</p>
---

Several things to remember each time the propane container is removed:

1. Check that ALL fittings are tight.
2. Check that ALL connections are tested with a propane leak detector (or soapy water) solution.
3. Open the main valve slowly to avoid a fast rush of propane to the excess flow valve causing propane freeze up. If you experience a propane "freeze-up," close the main valve and wait at least fifteen (15) minutes before trying again. Refer to the regulator manufacturer's operator manual.
4. Listen carefully - a "hissing" sound longer than one second may indicate a propane leak. If you feel there may be a leak present, close the valve and contact your dealer or qualified propane technician for repair assistance.
5. Replace all protective covers and caps on the propane system after filling. Make sure the valve is closed, the LP tray lever is locked for travel and the compartment door is securely latched.

## **Propane Regulator**

The two-stage regulator has the only moving components in the propane system. Its sole function is to reduce the pressure from the propane containers to a safe and consistent low operating pressure. The first stage reduces the container pressure to 10-13 lbs. The second stage reduces the 10-13 lbs. of pressure further to an operating pressure of 11" W.C. (water column) or 6.35 oz. of outlet pressure to your appliances.

The second stage is adjustable and will need to be adjusted by your dealer or qualified propane service technician for optimum performance (this adjustment should always be made with a properly calibrated manometer). If the pressure is too high, it affects performance and safety; if the pressure is too low, your appliances will not operate correctly.

If your RV is equipped with the "automatic" two-stage regulator, with both cylinders full of propane, turn the lever on the regulator towards the cylinder you wish to use first. This will now be the "supply" cylinder and the other the "reserve." Slowly open both cylinder valves. The indicator on top of the regulator will change to green. When the cylinder becomes empty, the indicator will change to a red. Now turn the regulator lever to the side of the "reserve" cylinder and the green signal should return. You may now remove the empty cylinder to have it refilled without interrupting the flow from the full bottle. After filling the cylinder, connect the pigtail hose and slowly open the bottle valve.

## **Propane System Hoses, Tubes, Pipes & Fittings**

The hoses, pipes, tubes and fittings used in your propane system are designed to withstand pressures exceeding those of the propane system. However, because environment and time can both contribute to the deterioration of these components, they must be inspected for wear at regular intervals. Be sure to inspect the hose before each season and when having the tank refilled. Look for signs of deterioration such as cracks or loss of flexibility. When replacing the hose or other propane components, always replace them with components of the same type and rating (check with your dealer).

Fittings are used to connect the various system components to each other. The P.O.L. fitting at the end of the propane supply hose is made of brass so that pipe sealants are not necessary to prevent leaking. It also has a left-handed thread, which means that it is turned clockwise to remove, and counter-clockwise to tighten. The P.O.L. fitting has been designed to help restrict the flow of LP gas in the event of a regulator failure or hose malfunction.



*Typical RV regulator, the red color on the dial indicates the LP bottles are empty. If the LP bottles were full, this dial would change to green.*

## **WARNING**

*Propane regulators must always be installed with the regulator vent facing downward. Regulators that are not located in baggage compartments have been equipped with a protective cover. Make sure the regulator vent faces downward and (if applicable) the cover is in place to minimize vent blockage that could result in excessive gas pressure causing fire or explosion.*



When you have double cylinders on your RV, use only one at a time. Otherwise, the propane supply will be drawn equally from both cylinders until the supply has been totally exhausted. Using one cylinder until it is empty, then using the second cylinder will allow you to fill the empty cylinder at your convenience without running totally out of propane.

**WARNING**

Do not use portable fuel-burning equipment, including wood and charcoal grills and stoves, inside the RV. The use of these items inside a RV may cause fires or asphyxiation (inability to breathe).

**WARNING**

Do not turn the gas range burner controls ON and allow propane gas to escape before lighting.



Do not remove the following label from your RV:

**WARNING**

IT IS NOT SAFE TO USE COOKING APPLIANCES FOR COMFORT HEATING. Cooking appliances need fresh air for safe operation.

Before operation:

1. Open overhead vent or turn on exhaust fan.
2. Open window.

FAILURE TO COMPLY COULD RESULT IN DEATH OR SERIOUS INJURY. LD-101

**Using the Propane System**

After the RV is completely set up and you are prepared for camping enjoyment, use the following steps for propane operation:

1. Close ALL burner valves, controls and pilot light valves.
2. Open the main valve in the propane container slowly to avoid a fast rush of propane vapor through the excess flow valve causing propane “freeze-up.” Should you experience propane “freeze-up,” close the main valve and wait 15 minutes before trying again.
3. Listen carefully as propane begins to flow. If a hissing noise is heard for more than one or two seconds, close the main valve and contact your dealer to have the propane system tested.
4. Light the appliances as needed and directed in the appropriate appliance manufacturer’s owner manual located in the Owner Information Package.

Make sure that you read and fully understand ALL safety requirements for handling and operation of the propane system. The Owner Information Package contains operator’s manuals for the various appliances hooked to your propane system. The propane system provides added benefits to your camping enjoyment; however, it must be handled with care. If you have any questions or concerns, consult with your dealer and/or the specific manufacturer.

**Cooking with Propane**

Unlike homes, the amount of oxygen supply is limited due to the size of the RV. Proper ventilation when using the cooking appliance(s) will help you avoid the danger of asphyxiation. Do not remove the following label from your RV; it is a reminder to provide an adequate supply of fresh air for combustion:

<p>IT IS NOT SAFE TO USE COOKING APPLIANCES FOR COMFORT HEATING</p> <p>Cooking appliances need fresh air for safe operation. Before operation</p> <ol style="list-style-type: none"><li>1) Open an overhead vent or turn on exhaust fan.</li><li>2) Open window</li></ol> <p>FAILURE TO COMPLY CAN RESULT IN DEATH OR SERIOUS INJURY.</p>	<p>IL EST DANGEREUX D'UTILISER LES APPAREILS DE CUISSON POUR LE CHAUFFAGE DES LOCAUX.</p> <p>Les appareils de cuisson nécessitent un apport d'air frais pour fonctionner en toute sécurité. Avant de les utiliser:</p> <ol style="list-style-type: none"><li>1) Ouvrir un évent ou actionner la hotte.</li><li>2) Ouvrir la fenêtre.</li></ol> <p>LE NON RESPECT DE CES INSTRUCTIONS PEUT ENTRAÎNER DES BLESSURES GRAVES OU LA MORT.</p> <p>LD-102</p>
---	--

**Calculating Propane Usage**

It is important to remember that (if applicable) your furnace, refrigerator, water heater and range all may use propane to operate. Each has a different BTU rating, and you will need to consider them to determine how long your propane supply will last.



Most RV gas appliances are operated intermittently. Propane consumption depends on individual use of appliances and the length of time operated. Unless there is heavy use of hot water, the water heater consumption of propane is minimal. During cool temperature or high wind conditions, furnace consumption can be extremely high.

To calculate your propane supply, take the BTU ratings for your propane appliances and divide that into the BTU availability. Each gallon of propane (3.86 liters) produces about 91,500 BTU's (46,514 kilojoules) of heat energy.

The following chart provides average propane consumption information.

Appliance	Average BTU Consumption/Hr.	Kilojoules/Hr.
Water Heater	8800	9280
Refrigerator	640-1200	680-1270
Furnace	16,000 - 35,000	16,880 - 36,930
Range w/ Oven	7100	7490
Range – Rear Burner	6500	6860
Range – Front Burner	9000	9490

### **Traveling with Propane**

Use care when fueling your tow vehicle. Make certain your propane container is properly fastened in place. Some states prohibit propane appliances to be operated during travel, especially in underground tunnels. Make sure you know the laws for the areas where you travel.

This page is intentionally blank

## Plumbing Systems

There are two different water systems in your RV: the fresh water system and the waste water system. The fresh water system consists of the fresh water holding tank, fresh water connections, water pump, outside shower assembly (if so equipped), water heater, faucets, shower or tub, and water purification system (if so equipped). The waste water system consists of the waste water holding tank, sewage holding tank, drains and toilet.

- Check all fittings, pressure and waste, for leaks before each trip or before vehicle storage as part of your normal maintenance.
- Inspect all faucets and sink connections (including drain baskets or filters).
- Inspect connections at the water pump and water heater.
- At the end of every trip, you should drain any unused water from the fresh water system.

### Fresh Water System

All water contains contaminant and mineral particles that can cause fresh water system odors. Untreated well water is a major source of water system odors. The fresh water (or potable water) system needs periodic sanitization and winterization to take care of all the components within the plumbing system and help discourage the growth of bacteria and other organisms that can contaminate the water supply.

### Monitor Panel

The interior wall-mounted monitor panel (located on the Command Center) allows you to monitor the fresh water, grey water, black water and auxiliary battery levels. These functions are controlled using the switches located on the monitor panel faceplate. The monitor panel operates on 12-volt DC power supplied by either the converter or auxiliary battery. Sensors installed in the holding tanks connect to a resistor assembly (relaying an electronic message to the display board). No power is drawn from the battery unless a switch is pushed or turned ON. Fuses for the monitor panel are located in the load center.

#### Operation

Press only one switch at a time. As you push either the “FRESH”, “BLACK,” “GRAY” or “GRAY2” switch, one or more LED lights will illuminate indicating that holding tank content level. When pushing the “BATT” switch, the highest LED light illuminated indicates the estimated auxiliary battery condition.

L = low at 6.0 volts      G = good at 12.1 volts  
 F = fair at 11.6 volts      C = charge at 12.7 volts

## **WARNING**

*DO NOT drink water deemed microbiologically unsafe or of unknown quality.*



*Photo shows a typical monitor panel section, located on the command center inside the RV.*

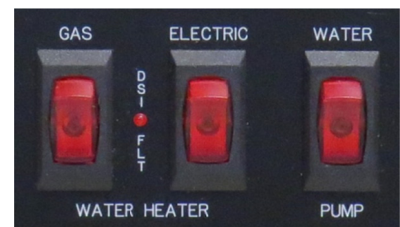

*Typical water heater and water pump ON/OFF switches, located on the Command Center inside the RV.*

**CAUTION**

Be careful not to overfill the fresh water holding tank. It can pressurize the tank, causing leakage and water damage and void the warranty. DO NOT leave the tank unattended while filling.



The fresh water connection should be unplugged (i.e., the non-toxic drinking water hose disconnected) when the RV is left unattended for any amount of time. If something would happen to the water system, this may help limit water damage to a smaller area.



Close-up of a typical utility center.

Water pump switch

When the water pump switch is ON the water pump runs until 45 pounds of pressure has been achieved. The red light will stay ON. Turn the water pump switch OFF when it is not in use.

Water heater switch

The "GAS" water heater switch enables propane operation of the water heater. The "ELECTRIC" water heater switch enables electric operation of the water heater.

Fresh Water Holding Tank

The fresh water tank can be pressure filled using the fresh water inlet. Plastic overflow tubes are plumbed into the fresh water holding tank to allow water to flow out of the water tank. Occasionally, you may see water coming from the overflow tubes (located underneath the RV) when the fresh water holding tank is filled. This is normal, and is caused by external circumstances, including the RV being parked on an incline, or the motion caused by starting or stopping the RV during travel.

Do not cap, block or modify the fresh water tank overflow tubes in any way. Enough water pressure can build up during the filling process to damage the plumbing system if the overflow tubes are obstructed.

Fresh Water Connections

There are two types of direct exterior fresh water connections in your RV: city water and gravity fill. The city water fill is typically used at a campground when there is access to a pressurized, potable water source. The gravity fill is generally used to when dry-camping.

Normal use (pressurized water source)

Use this setting if you are at a campground or other facility where the RV can be hooked up to an external, pressurized water source.

1. If needed, sanitize the water system (see **Sanitization**) and change the water filter.
2. At the docking station, turn the two Anderson KantLeak valves and fresh water tank access valve to match the diagram below:

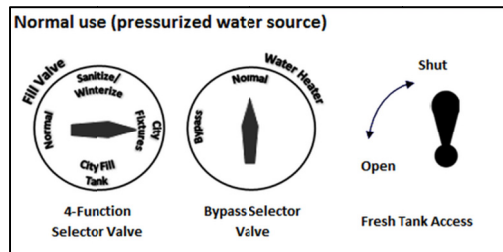

3. Attach a non-toxic drinking water hose to the water inlet connection.
4. Turn ON the water at the water source.
5. Enter the RV and open the cold water supply faucets to bleed air from the water lines. When the water lines are nearly full, you may experience some "air pockets." Allow them to escape before closing the cold water supply faucets.
6. The supply lines and faucets will fill, followed by the water heater.

To disconnect the city water fill

7. Shut OFF the water at the water source.
8. Disconnect the non-toxic drinking water hose.

Filling the fresh water tank (pressurized water source)

Follow these directions to fill the fresh water tank if you are at a campground or other facility where the RV can be hooked up to an external, pressurized water source.

1. If needed, sanitize the water system (see **Sanitization**) and change the water filter.
2. At the docking station, turn the two Anderson KantLeak valves and fresh water tank access valve to match the diagram below:

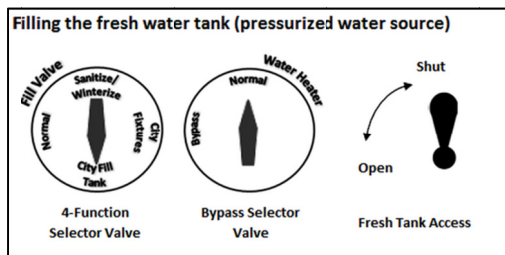

3. Attach a non-toxic drinking water hose to the water inlet.
4. Turn ON the water at the water source.
5. Shut OFF the water source when the fresh water tank is full or water comes out of the fresh water tank overflow tubes (whichever comes first).

Filling the fresh water tank (gravity fill)

Follow these directions to fill the fresh water tank if you are not at a campground or other facility where the RV can be hooked up to an external, pressurized water source.

1. If needed, sanitize the water system (see **Sanitization**) and change the water filter.
2. At the docking station, turn the two Anderson KantLeak valves and fresh water tank access valve to match the diagram below:



Do not remove the following label from your RV:

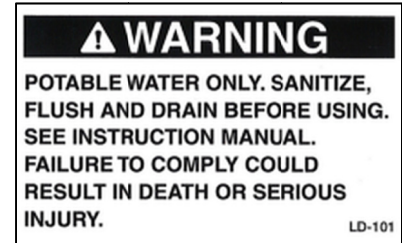

**CAUTION**

Not using a water pressure regulator when using city water may cause the o-rings to fail. To prevent damage to the plumbing system or components when using the city water connection, a water pressure regulator rated for 40 lbs. is recommended

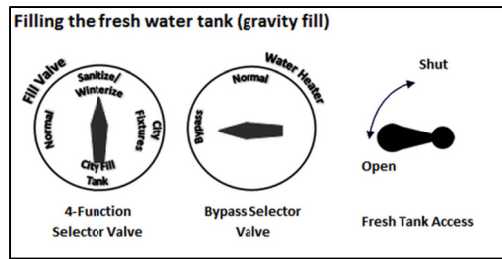

3. Attach a non-toxic drinking water hose to the water inlet. Put the other end of the hose in a container of potable water.
4. Turn ON the water pump until the container is empty, the fresh water tank is full, or water comes out of the fresh water tank overflow tubes (whichever comes first).

Filling the fresh water tank and water heater (gravity fill)

If you want to fill both the fresh water tank and the water heater - and you are not at a campground or other facility where the RV can be hooked up to an external, pressurized water source - follow the directions listed in the Filling the fresh water tank (gravity fill) section; however, at step 2 turn the valves in the position shown on the diagram below:

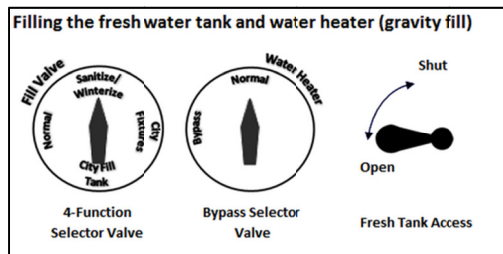

Dry camping

If you are camping with a filled the fresh water tank, to use the water system turn the two Anderson KantLeak valves and fresh water tank access valve to match the diagram below. Then turn ON the water pump (change the water filter, as needed):

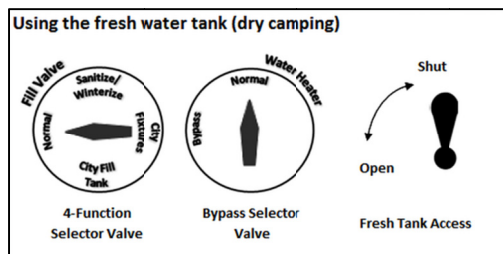

**Water Pressure Regulator (Customer Supplied)**

Excessive pressure from water supply systems may be encountered in some parks, especially in mountain regions. Water pressure regulators can protect your system against such high pressure. Water pressure regulators are available for

purchase from your RV dealer to protect the plumbing system against such high pressure.

### **12-Volt Water Pump**

Once activated, the water pump (also known as the on-demand pump) will self-prime, and provide water. The water pump continues to run until approximately 45 lbs. of pressure is achieved and shut off. The water pump will automatically restart when pressure drops. Some cycling may occur, depending on the volume of water being released. The water pump has a built-in check valve to prevent water from back flowing. The water pump incorporates a screen filter on the inlet side. This screen must be cleaned periodically.

### **Water Heater**

The water heater is designed to heat water quickly and efficiently. The water heater manufacturer has preset the sensing limit to maintain the water temperature when the water heater is activated. Read the safety and operating information provided in the manufacturer's manual before attempting to activate the water heater. Make sure the water heater is filled with water before use; even momentary operation of the water heater without water in it may result in non-warrantable damage to the tank and/or controls.

#### Operating instructions

Make sure the water heater is filled with water before use; even momentary operation of the water heater without water in it may result in damage to the tank and/or controls. Always open both the hot and cold water faucets when filling the fresh water tank to allow air pockets to be forced out of the water heater.

#### Draining and winterization

If the RV is to be stored over the winter months, the water heater must be drained to prevent damage from freezing. It is recommended the water heater be drained and bypassed during the winterization process particularly if introducing RV antifreeze into the plumbing system.

#### Odor from the hot water system

Many water supplies contain sufficient amounts of sulfur to produce an odor, often called "sulfur water." Sulfur water can be caused by a chemical action or by bacteria. Generally, sulfur water is not harmful, only unpleasant to smell. Refer to the water heater manufacturer owner manual for details on eliminating the odor from sulfur water. Odor from sulfur water is not a service problem.

### **WARNING**

*If you smell propane gas then **STOP!** Follow the procedures listed in the Propane System section of this manual before attempting to operate the water heater.*

### **WARNING**

*Hydrogen gas may result if you have not used the water heater for two weeks or more. HYDROGEN GAS IS EXTREMELY FLAMMABLE. To reduce the risk of injury under these conditions, open the hot water faucet for several minutes at the kitchen sink before you use any electrical appliance connected to the hot water system. If hydrogen is present, you may hear what sounds like air escaping through the pipe as the water begins to flow. Hydrogen gas may be present even after water has been drained from the water heater tank. Open the faucet at the sink and allow the system to vent for five to ten minutes. Do not smoke or have any open flame near the open faucet while venting. On DSI water heater models, make sure the switch is OFF.*

### **WARNING**

*Do not replace any component part with an accessory part that is not authorized by the water heater manufacturer, such as an "add-on" electric heating element. Such items are not approved to be installed and could create an unsafe condition and will void all warranties.*

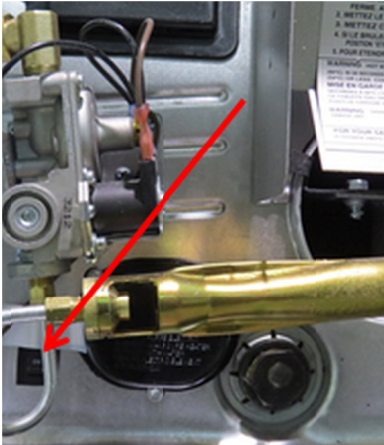

If the water heater does not work, make sure the power switch (indicated by the red arrow, located by removing the exterior water heater door) was not inadvertently switched OFF.



It is important that once the RV has returned to lower elevation (below 4500 feet) any high altitude deration or other adjustments be reversed for proper operation of the water heater.



The arrow in the above photo shows the P&T relief valve location on this particular water heater model.

Anode rod protection

The tank in the water heater is protected by a magnesium or aluminum anode, which prolongs the life of the tank by absorbing the corrosive action of hot water. Under normal use, the anode rod will deteriorate and because of this, the water heater manufacturer recommends the anode rod be replaced yearly. Water with high levels of iron and/or sulfate will increase the rate of deterioration; therefore, more frequent replacements may be required. If an anode rod is mostly eaten away, replace it with a new one. The water heater manufacturer recommends replacement of the anode rod when consumption or weight loss is greater than 75 percent.

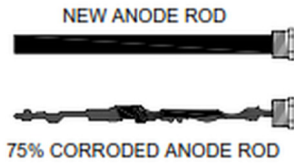

Replacement chart



Typical anode rod, installed

To access the anode rod, remove the exterior water heater door located on the exterior sidewall. The installed anode rod location is indicated by the red arrow in the photo above

Operating the water heater without the proper anode rod protection will decrease tank life and will void the tank manufacturer's warranty on the tank. To extend the anode life, drain the water from the water heater tank whenever the RV is not being used. Avoid any extended time of non-use with water in the tank.

To prevent a water leak when replacing the anode rod, a pipe thread sealant approved for potable water (such as Teflon Tape) must be applied to the threads of the anode rod. Proper application of a thread sealant will not interfere with the anode's

High altitude deration

Operation of the water heater at high altitudes may require de-rating. If the water heater is not properly de-rated, lack of sufficient oxygen for combustion may produce improper burner operation. Pilot outage caused by burner lift-off or sooting from a yellow burner may occur, indicating the possibility of carbon monoxide. You may also notice a lack of efficiency in heating the water because of incomplete combustion of the burner at these higher altitudes. Consult with a local propane company, your dealer or the water heater manufacturer for proper de-rating of the water heater. Change out of the orifice (de-rating) should be done by the dealer or a qualified service agency.



Pressure & temperature relief valve

When cold water is heated in the water heater tank, the water pressure will rise. For this reason, a pressure and temperature (P&T) relief valve is required for safety in all water heaters. It is normal for the P&T relief valve to release a small quantity of water during the heating cycle and does not indicate a defective P&T relief valve. One way to reduce the frequency of the water weeping or dripping from the P&T relief valve is to maintain an air pocket at the top of the water heater. This air pocket will form in the tank by design; however, it will be reduced over time by the everyday use of your water heater (refer to the manufacturer's manual); If the weeping persists, consult your dealer or a service agency authorized by the water heater manufacturer.

Water filter

Your RV is equipped with a factory installed water filter. For best results, replace the water filter cartridge seasonally or as needed, whichever comes first. When replacing a water filter cartridge, flush the new cartridge approximately two (2) minutes to remove any carbon fines. Do not use carbon cartridges where water is microbiologically unsafe or of unknown quality.

Winterization or sanitization instructions:

- Remove the filter housing before using anti-freeze to winterize the RV system or using sanitizing solution to sanitize the RV system.
- Remove the water filter cartridge and store.
- Reinstall the empty filter housing back on the cap. Do not allow the filter housing to freeze!
- Proceed to winterize (or sanitize) the RV
- Flush the housing thoroughly before using the water filter system after winterization (or sanitization).

Outside Shower

A handheld shower assembly with both hot and cold water is available for washing or rinsing outside the RV at the utility center.

1. Be sure the water heater is ON and had sufficient time to heat the water.
2. If dry camping, be sure the 12-volt water pump is ON.
3. Open the outside shower door to remove the hand held showerhead and hose from its holder.
4. Turn ON the hot and cold faucet knobs, and adjust the water temperature as desired.
5. To activate the hand held shower turn ON the sprayer head attachment (some models).



*The maximum operating water temperature for the Flowmatic Systems Inc. ® Flow-Pur® water filter is 125°F (52°C). The maximum operating pressure is 125 PSI (8.75 BAR).*



*Typical outside shower. Remove the drain plug at the water hose access (indicated by the arrow) to allow excess liquids to drain out of the compartment area. This drain plug is NOT designed to sit flush with the compartment floor when inserted in the travel (and storage) position.*

6. To cease operation, close the faucet knobs. After the water has been allowed to drain from the sprayer head, replace it in the utility center. Any remaining water in the shower hose will drip or run out; this is not a leak but performs as intended. Make sure that the hose is not pinched and the sprayer head is not damaged when the compartment door is closed.

### **Faucets**

The faucets inside your RV operate much the same way as the faucets in your home. Make sure there is sufficient water available and, if dry camping, the 12-volt water pump is turned ON before operating. To open the faucets, turn the hot and cold knobs ON and adjust the temperature to your comfort level. Close the faucets when a sufficient amount of water is released.

### **Bathroom Shower**

The shower faucet requires a vacuum breaker when the shower hose and head are used to prevent siphoning water through the hose from another fixture, and to prevent water from being contained in the hose. The showerhead DOES NOT have a complete shut-off valve (the complete shut-off is at the faucet). The showerhead may drip slightly in the OFF position after use; this is normal and does not indicate a leak or defect. There may be air in the plumbing lines that will need to be bled out before a steady stream of water comes from the faucet.

The bathing facilities in your RV function similar to those in your home. Keep the water heater and holding tank capacities in mind when using the fresh water system. The used water will

drain through the plumbing pipes into the grey water holding tank.

1. Be sure the water heater is ON and had sufficient time to heat the water.
2. If dry camping, be sure your 12-volt water pump is ON.
3. Adjust the hot and cold faucets to the desired temperature before bathing.
4. To conserve water while showering, wet down and turn the water OFF while you use soap, then rinse.
5. When you are finished, shut the water faucets OFF.

Unlike your home, the RV does not contain a water pressure balance valve. If someone is using the shower, it is recommended that the fresh water system NOT BE USED until they are finished.

### Maintenance

Read the manufacturer's operator manual. The shower walls in your RV are made of fiberglass material. Use a mild detergent soap and warm water to clean. DO NOT use gritty or abrasive particle soaps or scouring compound to clean the fiberglass.

### Draining the Fresh Water System

The low-point drains valves release water in the supply lines by opening the valves and all faucets. The water heater has its own drain plug. To drain the permanent fresh water holding tank and supply lines:

1. Open all faucets, including the outside shower.
2. Open the white fresh water holding tank gate valve.
3. Unscrew and remove the caps from the "low point drains." As their name indicates, the valves will be at the lowest point of water lines.
4. Drain the sink by removing the drain cap.
5. Turn ON the water pump and allow it to run as needed.
6. Make sure the "water heater bypass" valve is set to "Normal" (horizontal).
7. Relieve the water pressure using the water heater P&T valve BEFORE removing the water heater drain plug. Otherwise, if there is any water pressure present the water will spray out of the opening when the drain plug is removed.
8. Remove and store the water filter cartridge.

When you are finished draining the fresh water system, reverse these steps and, dump the grey and black water holding tanks at an appropriate facility or according to local public codes. It is normal for some liquid to remain in the fresh water tank after drainage procedure.

### Sanitizing the Potable Water System

To assure complete sanitation of your potable water system, the following procedures are recommended for a new system, for one that has not been used for a period of time, and for one which may have become contaminated:

1. Prepare a chlorine solution using one (1) gallon of water and one-quarter (1/4) cup of household bleach (5% sodium hypochlorite solution). Prepare approximately one (1) gallon of solution for each fifteen (15) gallons of holding tank capacity. Note: as an option, several commercial solutions are available and should be used as directed on the package.
2. Level the RV.
3. Close the fresh water system gate valve.
4. Close the drain valves.



*The white arrow indicates the blue and red colored low point drain lines.*

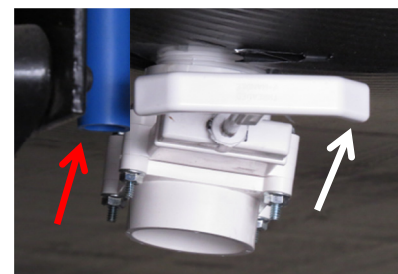

*The white arrow indicates the fresh tank drain valve. The red arrow indicates the fresh water tank overflow tube/vent line (valve & drain locations vary by model).*



*Please read, understand and follow all instructions before beginning the winterization process. It may be easier to winterize the RV with another person to assist you. If needed, contact your dealer for assistance.*

- At the docking station, turn the two Anderson KantLeak valves and fresh water tank access valve to match the diagram below:

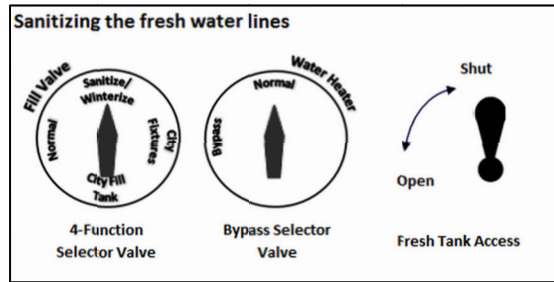

- Remove the water filter from the water filter housing.
- Connect your garden hose – not your potable water hose – to the water inlet and place the other end in the container of chlorine solution.
- Turn on the water pump to until the container containing the chlorine solution is empty.
- Complete filling the tank with fresh water.
- Operate all faucets to release trapped air.
- At the docking station, turn the two Anderson KantLeak valves and fresh water tank access valve to match the diagram below:

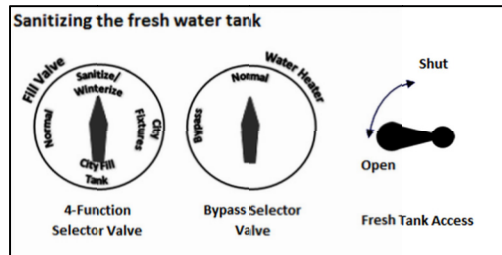

- Fill the container with 3 gallons of household bleach (5% sodium hypochlorite solution).
- Insert your garden hose into the container of bleach and turn ON the water pump until the container is empty.
- At the docking station, turn the two Anderson KantLeak valves and fresh water tank access valve to match the diagram below:

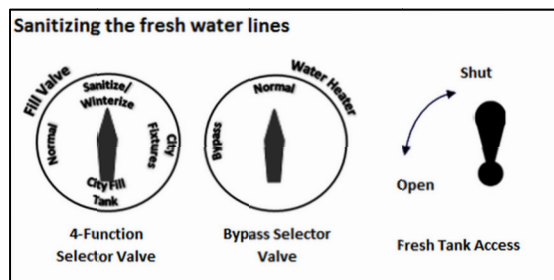

- Shut OFF the water pump.

15. Connect the other end of the garden hose to a pressured water source and turn it on, or fill the container with potable water and turn ON the water pump. The bleach and water will mix together to form a chlorine solution in the water tank. Continue this step until the chlorine solution runs out of the fresh water tank overflow tubes or the fresh water tank is full (whichever comes first).
16. Allow solution to stand for three (3) hours.
17. Drain the chlorine solution, and flush the fresh water system with fresh potable water.

To remove excessive chlorine taste or odor which may remain

18. Prepare a solution of one (1) quart vinegar to five (5) gallons water and repeat steps 2-13 above (at step 8, place the hose in the container of vinegar solution). Allow solution to agitate in tank by intermittent vehicle motion (several days if possible).
19. Drain tank and flush with fresh potable water.

**Winterizing the Plumbing System**

Preparing your RV for colder weather or storage is very important for most states and Canada. Failure to prepare your RV may cause water supply lines and the water heater to freeze. No commodity or product should be added to the fresh water system to ensure freeze protection other than RV antifreeze. The RV should be winterized at the end of the camping season or when the RV will be exposed to temperatures that will fall at or below 32°F (0°C). Repairs due to freezing are not covered under warranty.

2. Level the RV and drain the fresh water plumbing system.
3. Make sure the water heater 12-volt and 120-volt interior control switches are OFF.

At the docking station, turn the two Anderson KantLeak valves and separate small black valve to match the diagram below:

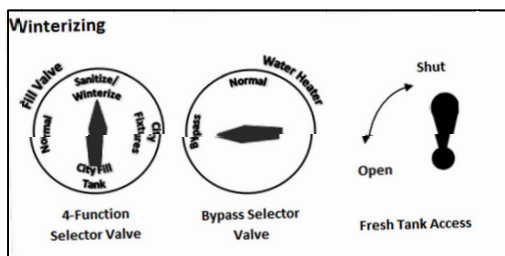

4. Remove the water filter from the water filter housing.
5. Make sure the "fresh tank drain" is open, and the "low point drains" are closed.

6. Insert the garden hose into a container of RV antifreeze solution (this quantity should be enough to winterize the RV); attach the other end to the winterization fill.
7. Turn the water pump ON.
8. Open the hot water line on all the faucets (kitchen, lavatory, shower and outside shower) until RV antifreeze begins to flow continuously.
9. Close the faucet hot water lines and repeat with the cold water lines on all the faucets. Do not forget to run RV antifreeze through the toilet, sink and shower drains.

When you are done adding RV antifreeze

10. Remove the garden hose from the container of RV antifreeze.
11. To prevent staining, wipe the RV antifreeze out of the sinks, shower (or tub), sink and toilet using a soft, dry cloth.

**Black/Grey Water System**

Water from the sinks and shower flow into the grey water (or waste water) holding tank. Water from the toilet will flow into the sewage (or black water) holding tank. The weight of the holding tank contents is not calculated into the RV cargo carrying capacity (this extra weight would reduce your available cargo capacity). Traveling with full holding tank(s) could possibly cause you to exceed the individual tire ratings and/or the GAWR or GVWR. Potential damage to suspension components, such as springs, tires and axles, could result.

If your RV holding tank(s) are located behind the axles, the weight of the full tank(s) will reduce the hitch weight. Trailer sway and other handling difficulties can be the result of the hitch weight being too light. Dump the grey and black water holding tanks before traveling to avoid carrying unnecessary weight. If you are dry camping and cannot immediately empty your holding tanks, reduce your vehicle speed until you reach a dumping station. Before using the RV or after dumping the grey and black water holding tanks, always add the proper amount of deodorant to the black water tank to prevent malodors and help break down holding tank contents (unless winterizing). Follow the deodorant bottle or package instructions. Driving to a disposal site will normally loosen any accumulated waste debris or solids from the sides of the holding tanks.

**Drain Pipes With P-Traps**

The drain pipes may be equipped with a “P-trap” installed to help prevent odors from escaping into the RV. During travel, water from the P-traps may spill and permit odors into the RV. By adding water and using a RV approved deodorizing agent you will dissolve the contents faster and will keep the drain lines

** WARNING**

*Never travel with full black or grey water holding tanks. This not only wastes your fuel but depending on the location of the tank(s), it can affect your tow vehicle handling characteristics.*

** WARNING**

*Do not add automotive antifreeze or caustic chemicals such as laundry detergents into the holding tanks. Although these products may have a deodorizing effect, they may damage the plastic and rubber parts of the plumbing system or the components.*

and tanks clean and free flowing. These chemicals are available at an RV supply store or your dealer.

### **Drain Pipes With Dry Sealing Valve**

Your RV may be equipped with a dry sealing valve that prevents the escape of odors from your waste system and eliminates the need for P-traps. Should the RV drain piping system become clogged and a mechanical cleanout tool is used to open the drain pipe, it is important that the dry valve be removed before passing the cleanout tool through the piping. Passing a mechanical cleanout tool through the waterless valve may cause damage to the internal seal that may potentially allow sewer gases to escape to the RV interior

### **Vents & Vent Pipes**

Another important part of this system is the vent pipes and vents that release air from the grey and black water holding tanks. The exterior vent cap is attached to the roof and must be kept clear of obstructions to perform as intended. On some models, the vent pipe may be part of the drainage system referred to as a "wet vent" (water flows downward as air flows upward in the same pipe).

### **Black/Grey Water Holding Tanks**

When connected to the sewer drain line at a campground, keep the "black tank drain" valve closed until the holding tank is at least  $\frac{3}{4}$  full. This should provide sufficient water to assist in complete draining of the black water holding tank. Repeat as needed. Never leave the black tank drain in the open position continuously when connected to the campground sewer system.

### **Emptying the Black & Grey Water Tanks**

The two grey tank drain valves and one black tank drain valve (also called dump valves) are located in the docking station. Always drain the black water holding tank first so the following grey tank waste water can help rinse any solids or debris from the dump outlet and sewer hose.

1. To make drainage easier, level the RV.
2. Locate the "Sewer Outlet Connection" and remove the sewer hose housing dust cap, and attach your sewer hose (customer supplied).
3. Place the other end of the sewer hose into the approved dump station.
4. Open the black tank dump valve by carefully pulling it out towards you (close it by pushing it shut when the black water holding tank is emptied).



*Typical sewer outlet connection, located on the off-door side.*



Typical sewer tank flusher, located in this instance on the exterior RV sidewall.

## **NOTICE**

*It is important to prevent solid waste buildup. Follow the toilet manufacturer's recommended instructions each time after emptying the black water holding tank.*

5. Similarly, open each grey tank dump valve (one at a time) and close it after each grey holding tank is emptied).
6. Remove, clean and store the sewer hose.
7. Close the sewer hose housing dust cap.

You can locate many dump stations throughout the United States and Canada in Woodall's, Rand McNally Camp Guide, Good Sam Camp Guide, KOA Kampgrounds Camp Guide and various other publications. Some fuel stations also have dump stations. Please contact your dealer for assistance in the purchase and installation of a sewer hose or sewer hose extension (if needed).

### **Sewer Tank Flusher**

The sewer tank flusher is designed to rinse the interior of the black tank. A separate water hookup is located in the docking station. Flush the tank after dumping by:

1. Connecting the sewer hose and attaching a garden hose – not your fresh water hose – to the sewer tank inlet (see photo). Be sure the black tank gate valve is in the OPEN position!
2. Open the water supply to full pressure to flush tank.
3. When the water runs clear from the sewer hose, shut off the water supply and disconnect the garden hose from the water source. Do not disconnect hose from flush inlet until water has drained from system.

Do not leave any hose connected when not in use and do not add any check valves to this system.

### **Toilet**

The toilet is efficient and easy to operate. Generally, more water is required only when flushing solids. Prior to using the sanitation system, it is strongly recommended to flush the toilet several times to release sufficient water into the holding tank. If there is not a sufficient amount of water used during flushing, the waste materials may not evacuate properly from the drain line to the tank. Clogged tanks and pipes could eventually occur.

The toilet system will perform better when water is run for ten to fifteen seconds after flushing to ensure that the waste will proceed to the bottom of the tank. Unlike a toilet in a home, which uses four to seven gallons (18 - 32 liters) of water per flush, the average recreation vehicle system uses one to three quarts (1-3 liters). For added convenience and better sanitation system performance, it is advisable to always have four to six inches (10 - 15 cm) of water in the toilet.

To prevent help toilet blockage, always use RV grade single-ply toilet paper. Do not flush paper towels, diapers, sanitary napkins or other foreign objects down the RV toilet.



Sewage (black) tank preparation

1. Release one to two quarts (1 or 2 liters) of water into the toilet bowl.
2. Follow the directions on your toilet chemical bottle (customer supplied), by placing the recommended quantity of holding tank chemical into the toilet bowl.
3. Flush the toilet and allow at least two gallons (8 liters) of water to flow into the holding tank.

Waste (grey) holding tank preparation

No special preparation is required, however, placing a small quantity of chemicals into this tank, such as baking soda or an approved RV chemical, will reduce odors from food particles in the system.

Cleaning & Maintenance

The toilet should be cleaned regularly for maximum sanitation and operational efficiency. Do not use chlorine (undiluted) or caustic chemicals, such as laundry bleach or drain opening types, in the toilet system. These products damage the seals in toilets and dump valves.

This page is intentionally blank

## **Slideout Systems**

Slideouts are designed to provide additional living space during stationary camping. The mechanical components are hydraulically driven or gear driven. Make sure you have sufficient power available before operating your slideout system, then level and stabilize the RV. If the RV is not level, the slideout rooms and/or mechanisms may become damaged as leveling helps keep the RV square so the slideouts extend/retract and seal correctly. Adding additional support is not necessary under the slideout rooms. Non-warranty damage can occur to your slideout system from improper use of aftermarket support jacks.

### *Operation*

The slide rooms will make creaking or squeaking noises during operation. These noises are normal especially during the break-in period while the components are seating properly. This will decrease after a few extend/retract cycles. Note that there will always be some noticeable noises when operating the slideout.

1. Level and stabilize the RV.
2. Be sure the auxiliary battery is fully charged or the RV is connected to shore power. Turn off all unnecessary lights to maximize available power.
3. Close all cabinet doors and drawers.
4. Before extending, be sure the area outside each slide room is free of obstacles such as trees, boulders, fences, etc.
5. Before extending or retracting, be sure the interior is clear of people, pets, furniture, clothing, etc. Move any furniture or other items that may be in the path of the slideout room.
6. Inspect the sides, top and bottom of the extended slide out room. If the outside of the slideout room is wet, wipe it dry before retracting it. Clean any water puddles or debris brought inside your RV from slideout operation immediately.
7. Press and hold the appropriate slide room switch to either IN or OUT, until the room is completely extended or retracted. Each slideout must be completely extended or retracted for the room weather seals to be effective. If you hold a slide room switch past when the room is fully extended or retracted damage may occur.

***Review the additional important safety alerts on the next pages before operating either the hydraulic or Schwintek slide systems. If a slide out system stalls out before reaching end of stroke OR if the slide room does not close and seal tightly, call your dealer or Grand Design RV Customer Service for trouble shooting and/or repair assistance.***

## **NOTICE**

***Ensure that the RV is level before operating the slideout room. Water leaks and other problems could result if the slideout is operated without leveling the RV.***



*Typical slide room switches, located in the Command Center:*

- *Slide Room 1 - operates both the living area and kitchen slide rooms.*
- *Slide Room 2 - operates the bedroom slide room*

## **NOTICE**

*For long-term storage, it is recommended that the slide rooms be closed (retracted).*

## **WARNING**

*The slideout mechanism has hard, sharp metal edges. Do not allow children to play under a slideout in the extended position. Failure to do so could result in serious injury or death.*

## **WARNING**

*Ensure the slideout is in the closed position prior to hooking the RV to the tow vehicle. **FAILURE TO FOLLOW THESE INSTRUCTIONS COULD RESULT IN SERIOUS INJURY OR DEATH.***

**CAUTION**

Do not place excessive weight in the slideout room. It can cause the slideout room to malfunction and cause damage to the slideout.

**WARNING**

Stand clear of the room's interior path and verify there are no exterior obstructions before extending or retracting the slide-out. Failure to do so could result in serious injury or death.

**WARNING**

The slideout room and mechanism are a potential crush hazard. Disconnect the auxiliary battery to disable power to the slideout(s) before working on or under the slideout(s). Failure to do so could result in serious injury or death.

**WARNING**

Your RV should be supported at both front and rear axles with jack stands before working underneath the RV. Failure to do so may result in personal injury or death.

**WARNING**

During this override procedure, the Schwintek slide room motors are not synchronized. Visually watch the slide room, and if one side is moving significantly slower than the other (or not at all), immediately stop and call your dealer or Grand Design RV Customer Service.

*Maintenance*

When a slideout room is extended snow, ice, blowing dirt and dust, and other debris may cling to the outside surfaces of the room and mechanism. When the slideout is retracted, whatever is on the outside will be brought inside the RV. Before retracting the slideout, check the outside surfaces. Wipe them dry or clean as much as possible. If the slideout is extended for a long period, be sure to check for insect nests, etc. before retracting. Check for standing water on the slideout topper awning (if so equipped). Remember that the slideout seals are not designed to remove all the water or debris that may accumulate on the outside surfaces. You must wipe it off before retracting the slideout.

**Schwintek InWall Slideout System**

If the bedroom Schwintek InWall slideout does not extend or retract, follow these steps to override the system (it will be easier if you have one or more persons to assist you):

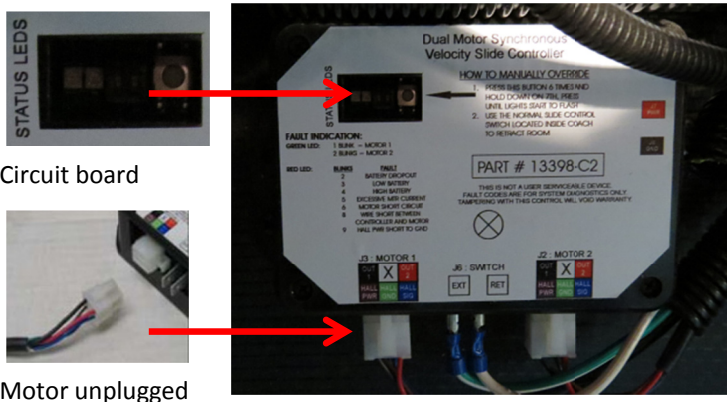

Typical Schwintek slide controller, located in the front facing compartment of your Solitude FW

*Electronic manual override (for board revision C1 and newer):*

1. Locate the circuit board.
2. Press the “mode button” six (6) times quickly, press a seventh (7<sup>th</sup>) time and hold for approximately five (5) seconds.
3. The RED and GREEN LED lights will begin to flash, confirming the override mode.
4. Release the “mode” button.
5. Back inside the RV, press and hold the Slide Room 2 switch “IN” button until the room comes completely in.

*Manually push the slide room in override*

1. Locate the circuit board.
2. Unplug both motors from circuit board (this releases the motor brake).

3. Push or pull slide room in as desired;
  - a. Larger rooms may require several people to push.
  - b. Keep both sides of room relatively even.
4. When the bedroom slide is completely in, plug both the motors back in to the control board (this applies the motor brake for road travel).

*Disengage motors, manually retract room and travel lock:*

1. Locate and remove motor retention screw located near the top of each vertical column.-
2. Bend back the wipe seal and visually locate motor.
3. Pull the motor up until disengaged, about 1/2". Replace the motor retention screw to hold the motor in this position.
4. Repeat this process for both sides of the slide room.
5. Push or pull the slide room back in to the opening, keeping the side of the slide room relatively even.
6. Re-engage motor to be ready for travel.
7. The room must be travel locked to keep room in place for road travel.

*Troubleshooting the Schwintek slide system*

**Error codes**

During operation, when an error occurs the board will use the LED's to indicate where the problem exists. For motor specific faults, the GREEN LED will blink one (1) time for motor 1, and two (2) times for motor 2. The RED LED will blink from two (2) to nine (9) times depending on the error code, the error codes are as follows:

RED LED error code	Error code description
2	Battery drop out: battery capacity low enough to drop below 6 volts while running.
3	Low battery: voltage below 8 volts at start of cycle
4	High battery: voltage greater than 18 volts
5	Excessive motor current: high amperage, also indicated by 1 side of slide continually stalling.
6	Motor short circuit: Motor or wiring to motor has shorted out.
8	Hall signal not present: Encoder is not providing a signal. Usually a wiring problem.
9	Hall power short to ground: Power to encoder has been shorted to ground. Usually a wiring problem.

When an error code is present, the board needs to be reset. Energizing the extend/retract switch resets the board. Energize the extend/retract switch again for normal operation.



Do not remove the following label from the interior Command Center:



*Step 1 – Typical Schwintek motor retention screw location, viewed from inside the RV.*



*Step 2 – Typical Schwintek motor location, viewed from inside the RV.*

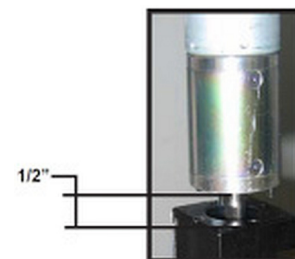

*Step 3 – Typical Schwintek motor, disengaged.*

## NOTICE

Never 'jump' or charge the auxiliary battery from the power connections on the InWall Controller. Always do this at the auxiliary battery.

## NOTICE

For optimum performance, the hydraulic slideout system requires a fully charged RV auxiliary battery be properly connected to the RV. Failure to do so will result in non-warranty damage.

### Checking Fuses

The Schwintek slide system requires a minimum of 30-amp fuse. Check the fuse box (located in the command center) for blown fuses, and replace as necessary. If the fuse blows immediately upon replacement there may be a problem with the wiring to the control box (contact your dealer for assistance).

### Low Voltage

The Schwintek slide controller is capable of operating the bedroom slide room with as little as 8-volts. But at these lower voltages the amperage requirement is greater. Check the voltage at the controller; if the voltage is lower than 11-volts, it is recommended that the auxiliary battery be placed on a charger until it is fully charged.

### Only one (1) side moving

The Schwintek slide system has a separate motor to operate each side of the room. If only 1 side of the room moves a short distance (2 to 4 inches) and stops;

- **Will nonmoving side move with help?** If only one (1) side of the room is moving, then with someone's assistance press the switch to extend or retract the room while pushing the nonmoving side in the appropriate direction. On larger rooms it may be necessary to have two (2) or more people pushing the room.
- **Nonmoving side moved manually.** Try to push the nonmoving side in and out. If a motor shaft has broken then it will be possible to move that side of the room several inches by hand. Larger rooms may require several people to push.

### *Schwintek slide system maintenance*

Check all four (4) gear racks installed on the exterior sidewalls of the slide room for debris (if found, remove debris immediately).

### **Hydraulic Slideout System – Through Frame**

Both your living area and kitchen slide rooms are powered by a hydraulic slide out system. It requires very little maintenance:

1. Change the fluid every 36 months (in reservoir ONLY!)
  - a. Check fluid only when jacks and slideouts are fully retracted.
  - b. Always fill the reservoir when the slideouts are in the fully retracted position. Filling the reservoir when the slideouts are extended will cause the reservoir to overflow into its compartment when slideouts are retracted.
  - c. When checking fluid level, fluid should be within ¼" of fill spout lip.

2. Check the fluid level every month.
3. Inspect and clean all pump unit electrical connections on the pump unit every 12 months.
4. Remove dirt and road debris from the slideout arms and cylinders as needed.
5. If slideouts are extended for lengthy periods, it is recommended to spray exposed cylinder rods with a silicone lubricant every seven (7) days for protection. If your RV is located in a salty environment, it is recommended to spray the rods every two (2) to three (3) days.

*Filling the reservoir*

The Lippert hydraulic slideout system uses automatic transmission fluid (ATF). Any ATF can be used. A full synthetic or synthetic blend works best such as Dexron II, Dexron III or Mercon 5. For best operation, fill the system within ¼” of the top when all slideouts and landing gear are complete retracted. The see-through reservoir (located in the front-facing compartment) makes it easy to check oil level. It is recommended that the oil level be checked prior to operating the system. Make sure the breather cap is free of contamination before removing, replacing or installing. In colder temperatures (less than 10°F), the cylinders and jacks may extend and retract slowly due to the fluid’s molecular nature. For cold weather operation, fluid specially formatted for low temperatures may be desirable.

1. Remove breather/fill cap.
2. Pour ATF into breather/fill cap.
  - a. Do not allow any contamination into reservoir during fill process.
  - b. Standard reservoir holds approximately 2 quarts (1.89 liters) of ATF.
3. Fill to within ¼” of top of reservoir.
4. Replace breather/fill cap when finished.

*How to override an individual slide room*

The instructions on overriding the hydraulic slide rooms reference the valves labeled in the photos to the right:

Valve	Description*	Typical location on the Solitude 369RL
D	Open/close the slide room valve block (which houses valves E & F)	Front facing comp
E	Extend/retract the hydraulic DS slide room	Front facing comp
F	Extend/retract the hydraulic ODS slide room	Front facing comp

\*DS = door-side, ODS = off-door side, comp = compartment

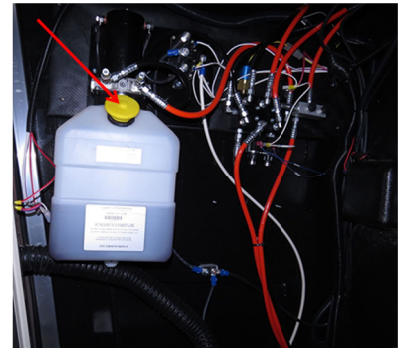

Typical reservoir for both the hydraulic landing gear and hydraulic slide system, it is located in the front-facing compartment. The red arrow points to the breather/fill cap.

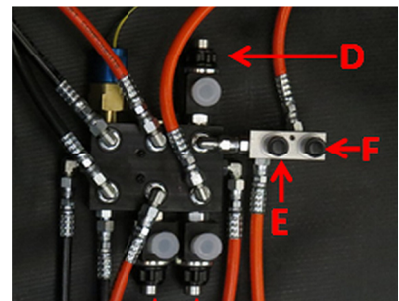

Typical hydraulic slide rooms override valves, generally located in the front facing compartment of the Solitude 369RL.



Typical protective seal, located on the end of the motor attached to the hydraulic reservoir.

- Rotating a hydraulic system override valve clockwise will open it.
- Rotating a hydraulic system override valve counter-clockwise will close it.

*How to override an individual slide room*

1. Make sure valve D is open. To open valve D, insert a 5/32" allen wrench into the manual override and rotate it 1.5 to 2 turns clockwise.
2. Make sure valves E and F are open (to open, rotate valve clockwise).
3. Peel off the protective seal located on the end of the motor that is attached to the hydraulic reservoir.
4. Attach a ¼" hex head bit to your hand drill (customer supplied), and insert it into coupler G (previously hidden under the protective seal). Run the drill clockwise to extend the level-up jacks and counter-clockwise to retract them.
5. When the slide rooms are in the desired position (extended or retracted), close valve D by inserting a 5/32" allen wrench into the manual override and rotating it 1.5 to 2 turns counter-clockwise until snug. Do not over tighten!

*Hydraulic slideout system maintenance*

It is recommended that when operating in harsh environments (road salt, ice buildup, etc.) the moving parts can be kept clean and can be washed with mild soap and water. No grease or lubrication is necessary and in some situations may be detrimental to the environment and long term dependability of the hydraulic slide system.

Although the system is designed to be almost maintenance free, actuate the slideouts and jacks once or twice a month to keep the seals and internal moving parts lubricated. Check for any visible signs of external damage or "leakage" before and after movement of the slide. When the rooms are out, visually inspect the exterior inner and outer assemblies of the slideout located underneath the room. Also inspect around the shoe of the leveling jacks for signs of leakage. Check for excess buildup of dirt or other foreign materials; remove any debris that may be present.

If the hydraulic slide system squeaks or makes any noises, it is permissible to apply a coat of lightweight oil to the drive shaft and roller areas of the slideout only, but remove any excess oil so dirt and debris do not build-up. DO NOT use grease.



## Appliances

The following contains quick highlights of the RV appliances and equipment. It is written for original factory-installed equipment usage. If there have been modifications or replacements made to your RV then these instructions may not apply (please contact the service center or technician who performed the modifications or substitutions if assistance is required).

*Refer to the manufacturer's user guides included in your Owner Information Package for detailed operating instructions for each specific component, or visit that manufacturer's website.*

### Refrigerator

The refrigerator is not intended for quick freezing or cooling. We recommend stocking it with pre-frozen or pre-cooled food when possible. The shelves should not be covered with paper or plastic and the food items should be arranged so air can circulate freely. Keep the area at the back of the refrigerator clean and free of debris. Check for obstructions in the exterior refrigerator vent area (i.e., spider webs, bird nests, etc.). Use a soft cloth to dust off the debris. For optimum efficiency and performance, it is recommended the refrigerator be checked at least twice a year as part of the routine maintenance.

### Microwave

Make sure there is sufficient 120-volt power available before operating the microwave. To prevent damage, ensure the microwave turntable is secured prior to traveling.

### Cooking with Propane

See the Propane Gas System section in this manual for important safety instructions.

### In Case of a Grease Fire

Grease is flammable. Never allow grease to collect around top burners or on the cook top surface. Wipe spills immediately. If a fire does start, follow these basic safety rules:

1. Have everyone evacuate the RV immediately.
2. After everyone is clear and accounted for, check the fire to see if you can attempt to put it out. If it is large or the fire is fuel-fed, get clear of the RV and have the Fire Department handle the emergency.
3. Try to smother a flaming pan with a tight-fitting lid or cookie sheet.
4. Never pick up a flaming pan.

## **⚠ DANGER**

*If you smell propane gas **STOP!** Quickly and carefully perform the procedure below:*

**⚠ DANGER**

**IF YOU SMELL PROPANE**

1. Extinguish any open flames, pilot lights and all smoking materials.
2. Do not touch electrical switches.
3. Shut off the propane supply at the container valve(s) or propane supply connection.
4. Open doors and other ventilating openings.
5. Leave the area until odor clears.
6. Have the propane system checked and leakage source corrected before using again.

**FAILURE TO COMPLY COULD RESULT IN EXPLOSION RESULTING IN DEATH OR SERIOUS INJURY. LD-101**



*Do not remove the following label from your RV:*

**⚠ WARNING**

**IT IS NOT SAFE TO USE COOKING APPLIANCES FOR COMFORT HEATING.**

Cooking appliances need fresh air for safe operation.

**Before operation:**

1. Open overhead vent or turn on exhaust fan.
2. Open window.

**FAILURE TO COMPLY COULD RESULT IN DEATH OR SERIOUS INJURY. LD-101**

## **⚠ WARNING**

*Do not use portable fuel burning equipment (i.e., wood and charcoal grills or stoves) inside the RV.*

## **⚠ WARNING**

*Do not turn the gas range burner controls ON and allow propane gas to escape before lighting.*

## Appliances

### **⚠ WARNING**

*During and after use, do not touch or let clothing or other flammable material come in contact with the top burners (or heating elements), burner grates or other areas near the top burners or oven until they have had sufficient time to cool. These areas can get hot enough to cause burns.*

*Never leave cooking food unattended. Turn pan handles inward, but not over the tops of the other range burners. Ensure that pans used are large enough to contain the food and avoid boil-overs. Heavy splattering or spills left on the cook top can ignite and cause burns.*

*If using glass, glass/ceramic, ceramic, earthenware or other glazed utensils (or cookware) verify it is safe for use on the top burners. Only certain types of utensils (or cookware) are suitable for surface or top burner use.*

*Do not cover the oven vent openings while the oven is in operation. Restricting the flow of combustion air will create an asphyxiation hazard.*



Do not remove the following label from under the washer hookups and drain:



Flaming grease outside of the pan can be extinguished with baking soda or a multipurpose dry chemical or foam-type fire extinguisher.

### **Range Top with Oven**

To prevent damage, always use the manufacturer recommended size flat bottom pan(s). Generally, the pan should be large enough to cover the range top burner, but not be more than one inch larger than the burner grate.

Do not use a broiler pan, griddle or any other large utensil that covers more than one range top burner at a time. This will create excessive heat that may cause melting, sooting or discoloration.

In addition, the use of undersized pans could expose a portion of the heating element to direct contact and may result in ignition of clothing. Proper relationship of pans to burner will improve efficiency.

### **Oven**

The propane gas oven ignites using a pilot light. If you have any questions contact your dealer or our customer service department. Do not use the oven as a storage area. For additional information refer to the manufacturer's owners' manual included in the warranty packet.

### **Washer/Dryer Prep**

If your RV was built with this feature, be aware the cabinet space provided is intended for the installation of an aftermarket RV-rated washer and dryer (customer supplied) only. Please consult your dealer or the appliance manufacturer for installation assistance.



*Dryer vent installation label, typically located inside the off-door side front bedroom closet.*



*Washer hot and cold water hookups and drain, typically located in the door-side front bedroom closet.*

## **Central Vacuum**

The central vacuum operates similar to one found in a house. To operate, make sure the RV has power before attaching the vacuum hose and opening the toe kick (typically located inside the RV by the stairs going up to the front of the RV) to turn the vacuum ON.



*In the photo above, the white arrow points to the toe kick and the red arrow points to the hose attachment*

The vacuum canister is located in the front compartment. To access and change the vacuum dust bag, depress the button on the cover to remove it. Be sure the new vacuum dust bag is attached correctly before reattaching the cover. To order new vacuum dust bags, call your dealer or call InterVac™ toll-free at 1-888-499-1925.



*Photo shows typical central vacuum, located in the front compartment*



*Photo shows cover removed and the dust bag not attached*



*Before vacuuming, check the dust bag and motor filter are installed in the power unit.*

This page is intentionally blank

## Heating & Cooling

The following contains quick highlights of the RV heating and cooling components. It is written for original factory-installed equipment usage. If there have been modifications or replacements made to your RV then these instructions may not apply (please contact the service center or technician who performed the modifications or substitutions if assistance is required).

*Refer to the manufacturer's user guides included in your Owner Information Package for detailed operating instructions for each specific component, or visit that manufacturer's website.*

## Ducting & Return Air

All heat discharges, registers and return air grills must be free and clear of obstructions. This includes all closeable registers that are intended to reduce airflow, not shut it off completely.

## Roof Vent

Your RV may have 12-volt DC powered and/or non-powered roof vents installed. Roof vents allow fresh air to circulate through the RV.

### MaxxFan Roof Vent

All MaxxFan keypad commands answer with audible beep:

- Press FAN ON and lid lifts automatically and fan starts running at the last selected speed.
- FAN OFF closes lid and shuts off the fan motor.
- Press FAN ON with the fan running and cycle thru 4 fan speeds. Fan is Exhaust Only.
- Lid OPEN key opens the fan lid without turning the fan motor on.
- Lid CLOSE key closes the fan lid, if the fan motor is running it will continue to run and enter "Ceiling Fan" mode.

## Thermostat

Use the 12-volt DC thermostat in your RV to set the temperature to your desired comfort setting. The four zones in your RV are as follows:

- Zone 1 – front bedroom air conditioner
- Zone 2 – main floor living area air conditioner
- Zone 3 – garage air conditioner
- Zone 4 – not applicable



*Typical Dometic Climate Control thermostat*



*Typical temperature sensor (wall-mounted).*



*Typical MaxxFan wall control*

## **NOTICE**

*Do not leave a roof vent open when the RV is stored or unattended for long periods. High winds, other unusual conditions or obstructions may occur; and if so, the resulting leakage could cause non-warrantable damage.*

## NOTICE

*Do not operate the air conditioner without the return air filter. Operating the system without the filter allows the lint and dirt that is normally stopped by the filter to accumulate on the cooling coil of the air conditioner. This also will lead to a loss of air volume, possible equipment damage and an expensive cleaning process.*

## WARNING

*The furnace should be inspected periodically (monthly during the heating season) for presence of soot on the vent. Soot is formed whenever combustion is incomplete. This is a visual warning that the furnace is operating in an unsafe manner. If soot is observed on the vent, immediately shut the furnace OFF and contact a qualified service agency. Operating the furnace under this condition could lead to serious property damage, personal injury or loss of life.*

## WARNING

*To ensure your personal safety, do not obstruct or alter the furnace in any manner. Do not install screens over the vent for any reason. Screens will become restricted and cause unsafe furnace operation. For your safety, only OEM factory authorized parts are to be used on your furnace.*

## Air Conditioner

Your RV has a roof mounted air conditioning system that is controlled by a thermostat. Make sure you have sufficient power available before operating the air conditioner.

### Capability vs. Environment

At best, a properly functioning roof air conditioner will cool the intake air it receives by 20 degrees F. The capability of the air conditioner to maintain the desired inside temperature is directly affected by the heat gain of the RV. During extreme high outdoor temperatures, the heat gain of the vehicle may be reduced by:

### Parking the RV in a shaded area

1. Keep the blinds down or drapes shut.
2. Operating the air conditioner on High Fan/Cooling mode will provide the maximum efficiency in high humidity or high temperatures.
3. Using awnings to block direct sunlight exposure on the RV.
4. Avoiding use of heat producing appliances.
5. Giving the air conditioner a “head start” by turning it on early in the morning.

### Air conditioner gasket

A special foam gasket is placed between the roof material and the sub-frame of the air conditioner to guard against water leakage. The air conditioner is subjected to wind pressures along with motor vibration during normal operation.

Inspect the mounting bolts for tightness to ensure there is no leakage or looseness at least annually. Re-tighten bolts when they are loose. DO NOT over tighten these bolts as it may damage this gasket.

The air conditioner gasket is a wearable part that eventually will need to be replaced as normal maintenance. To gain access to the bolts, remove the filtered panel cover on central air systems or the entire air box on non-central air conditioners.

### Heat pump

A heat pump is one base unit that can operate in two modes, heating or cooling. The travel or flow of the refrigerant is reversed depending on which cycle you choose to operate:

- *Cooling Mode: Heat is removed from the inside air and released to the outside air.*
- *Heating Mode: Heat is removed from the outside air and released to the inside air.*

## **Furnace**

The RV furnace installed in the RV is controlled by a thermostat. The furnace requires both 12-volt power and propane gas for full operation. Make sure you have sufficient power available before operating your furnace. If you have any questions contact your dealer or Grand Design RV Customer Service.

A qualified RV technician should perform all furnace maintenance at least once a year (more often depending on furnace usage). Never attempt to repair the furnace yourself.

## **Fireplace**

Refer to the OEM manual for operation, service and maintenance information. If you have further questions, please contact your dealer.

## **Patio Awning**

Please refer to the awning manufacturer's operators manual. Keep your awning in good condition to prevent costly repairs. It is very important to keep the awning clean. If weather conditions are windy or stormy, close the awning into the travel mode position. Shut the awning in the travel position if you will be away from the RV for an extended period of time.

## **Slideout Awnings**

If equipped, a slideout awning (also called a "topper") will automatically open and close along with the slide-room. When fully extended, the topper is level (which may cause water to puddle on top of the canopy). As the slide-room is closed, the topper will roll up and cause any puddles to spill over the sides of the awning.

Before retracting the slide-room, check to make sure the slide out awning is free of any debris (leaves, twigs, etc.), which can damage the awning or slide-room components.



*Typical patio awning control, located in the Command Center*

### **⚠️ WARNING**

*Awnings must be closed (and locked if applicable) while the RV is in transit.*

### **⚠️ WARNING**

*DO NOT attempt any repairs to any awning (patio awning or slideout awning). The awning roller tube is under extreme spring tension. Repairs should only be performed by an authorized dealer and/or repair center.*

This page is intentionally blank



## **Electronics**

### **Audio/Visual System Guide**

The following is a basic overview of the audio/visual (A/V) electronics operation. The information in this section is written for original factory-installed equipment usage. If there have been modifications or replacements made to your electronics system then these instructions may not apply (please contact the service center or technician who performed the modifications or substitutions if assistance is required).

*Refer to the manufacturer's user guides included in your Owner Information Package for detailed operating instructions for each specific component, or visit that manufacturer's website.*

#### **Radio operation:**

1. Turn ON the radio.
2. Select speaker output using the controls on the radio face (radio sound does not run through the sound bar).

#### **CD operation**

1. Turn ON the radio.
2. Select speaker output using the controls on the radio face (radio sound does not run through the sound bar).
3. Insert CD to play.

#### **TV operation**

1. Turn on the TV power supply.
2. Crank the TV antenna up.
3. Turn on the TV and select your signal input using the "source" button.
4. Turn ON the sound bar (the TV speakers are not used, nor does TV sound run through the radio speakers).

#### **DVD operation**

1. Turn off the TV power supply.
2. Turn on the TV.
3. Turn ON the sound bar (the TV speakers are not used, nor does TV sound run through the radio speakers).
4. Insert DVD to play.

### **TV Reception Basics**

Television stations broadcast their signal "over the air" to surrounding areas. TV antennas are designed to receive the signal broadcasted by the transmitters. Picture quality depends on the type of the antenna and the distance from the transmitter. The further you are from the transmitter, the worse the picture becomes. TV broadcasting is a point-to-point communication. Any obstructions between the transmitter and the antenna will degrade the signal strength, affecting the picture quality.



*Typical speaker controls, located on the stereo front face:*

*A – operates the living room speakers.*

*B – operates the bedroom speakers.*

*C – operates the exterior speakers.*

*You can choose any speaker combination (A, B and/or C) to play sound through the radio or CD.*



*Many television stations have changed from VHF to UHF channels. UHF channels operate at higher frequencies; the signal does not travel as far as those of VHF. If your TV is digital, you do not need a converter box or any other external, add-on device. If your antenna was working prior to the digital change, it is probably working now. Check the TV or the settings if you have problems receiving DTV channels. For more troubleshooting tips, go to [www.antennatek.com](http://www.antennatek.com).*

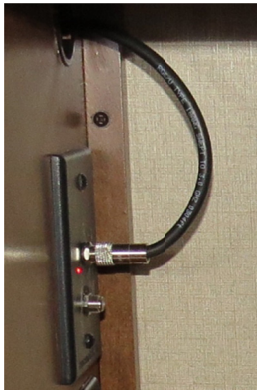

Typical TV signal booster, located in the cabinet to the right of the living room TV on some Solitude 369RL models. In the photo, the ON/OFF button is to the right of the coax cable.

### **CAUTION**

The TV power supply should be turned OFF when connecting and/or disconnecting the cables to the power supply and antenna, but should be turned ON when testing for voltage.

### **WARNING**

Do not raise the TV antenna near overhead electrical wires as contact may cause injury or death.

### **WARNING**

Make sure the television antenna is in the travel position (cranked down) before moving the RV. Failure to lower the antenna into the travel position before traveling may damage the antenna. The RV must not be driven with the TV antenna in a raised or partially raised position.

## **TV Signal Booster**

For good station reception, the TV signal booster must be turned ON to view local television stations. Turning the TV signal booster ON sends 12-volt DC through the cable to the TV roof antenna. The voltage energizes the transistors in the antenna head amplifier.

Turn the TV signal booster OFF to view cable or satellite television, or to use a DVD.

## **TV Roof Antenna**

To view local stations at either (or both) the front or bedroom television sets using the television antenna, make sure the TV power supply is ON and the TV roof antenna is raised to the operating position. The following is an overview of the antenna operation. Refer to the manufacturer's user guide included in your Owner Information Package for detailed operating instructions, or visit the manufacturer's website.

### To ensure proper reception, when using digital TV:

1. Raise your antenna and point it towards the signal transmitter. You may find the exact location of the transmitting towers at [www.fcc.gov](http://www.fcc.gov).
2. Turn the switch on the TV signal booster ON, and then turn the power to your TV ON. On the TV menu, set the input of the TV to "antenna," "broadcast", or OFF Air.
3. Scan for channels. If you are not satisfied with the quantity of channels you have received, rotate the antenna 90 degrees and rescan for channels. If your TV has the signal strength option, use it to fine-tune the antenna for maximum signal strength.

### When using analog TV:

1. Disconnect the coaxial cable from the TV and connect it to the input of the converter box. Use an extra coaxial cable to connect the output of the converter box to the input of the TV.
2. Turn on the power to the converter box.
3. Raise your antenna and point it towards the signal transmitter. You can find the available channels for your location at [www.fcc.gov](http://www.fcc.gov)
4. Turn the switch on the wall plate ON, and then turn the power on your TV ON. On the TV menu, set the input of the TV to "antenna," "broadcast" or OFF Air. Set the TV to either channel 3 or 4, depending on your area.
5. Scan for channels. If you are not satisfied with the quantity of channels you have received, rotate the antenna 90 degrees and rescan for channels. If your converter box has the signal strength option, use it to fine-tune the antenna for maximum signal strength.

6. Select different channels to watch by using the remote of the converter box, not the TV.

#### To Raise & Rotate Antenna

1. Rotate elevation handle clockwise. A clicking sound will occur when the antenna is completely extended.
2. Switch ON the main power supply (amplified models only, the red LED indicator illuminates indicating amplified reception).
3. Switch ON the television and tune in a suitable station. Pull rotation handle down to disengage gear from ceiling plate and rotate antenna until the picture and sound are clearest.

#### To Lower Antenna

1. Pull the rotation handle down to disengage gear from ceiling plate and rotate the antenna until the pointer on the ceiling plate is aligned with the pointer on the rotation handle. Rotate elevation handle counter-clockwise until you hear the antenna touch the roof (resistance will be felt in the handle).
2. You may want to switch the TV signal booster off. Amplified reception is possible while driving if your antenna is in the full down position.

### **Cable/Satellite Outlet**

There are RG-6 coax cable/satellite outlet connections located in the utility center (see diagram, next page). Please refer to the (customer supplied) satellite manufacturer's instructions for setup, care and maintenance.

## **⚠ WARNING**

*Lowering the antenna with the pointers misaligned may damage the antenna.*



*Typical cable/satellite outlet, located in the utility center*

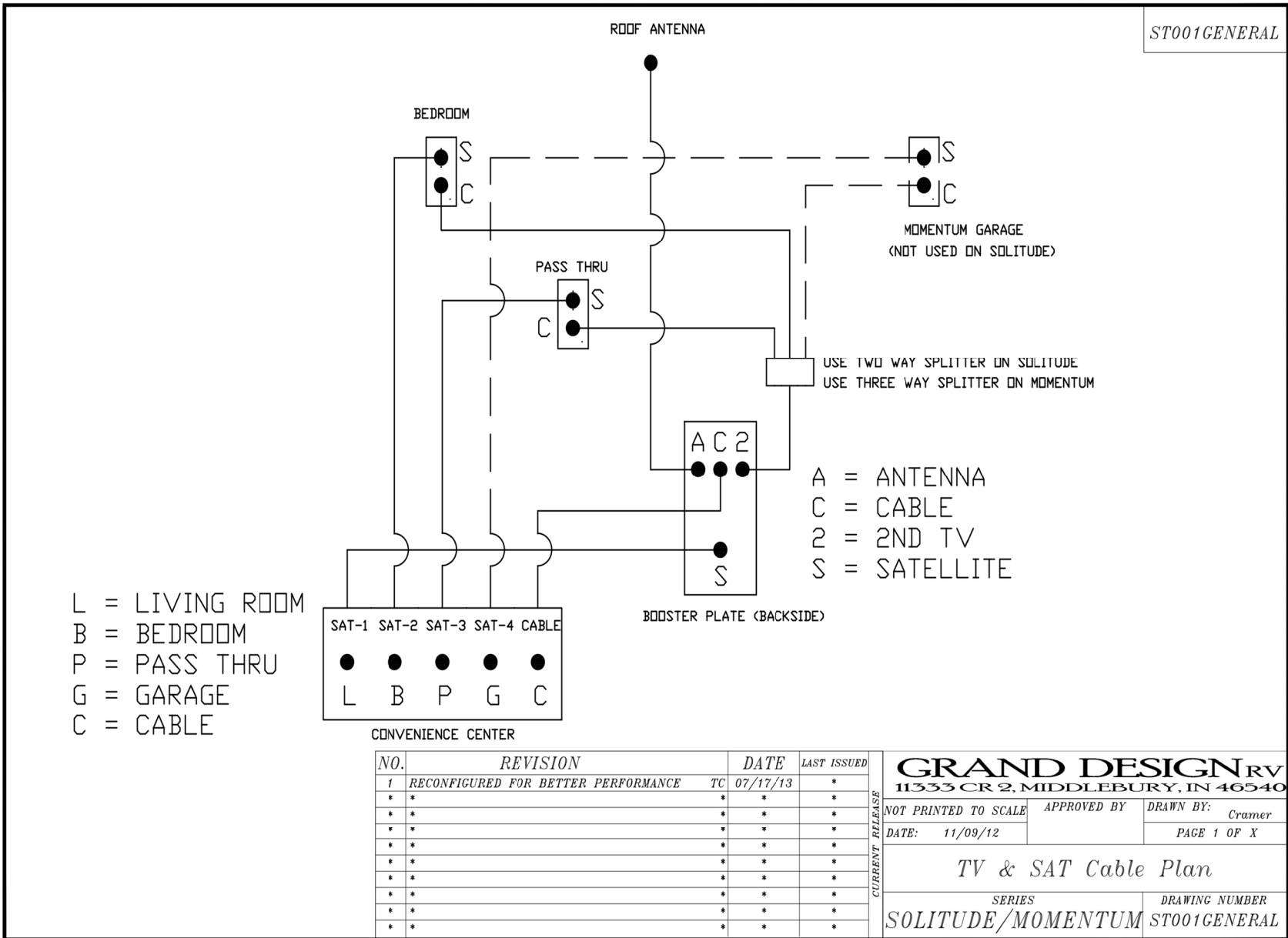

L = LIVING ROOM  
 B = BEDROOM  
 P = PASS THRU  
 G = GARAGE  
 C = CABLE

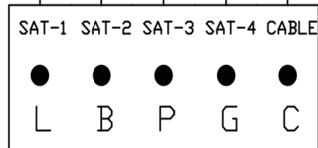

NO.	REVISION	DATE	LAST ISSUED
1	RECONFIGURED FOR BETTER PERFORMANCE TC	07/17/13	*
*	*	*	*
*	*	*	*
*	*	*	*
*	*	*	*
*	*	*	*
*	*	*	*
*	*	*	*
*	*	*	*
*	*	*	*

**GRAND DESIGN RV**  
 11333 CR 2, MIDDLEBURY, IN 46540

NOT PRINTED TO SCALE    APPROVED BY    DRAWN BY: Cramer

DATE: 11/09/12    PAGE 1 OF X

*TV & SAT Cable Plan*

SERIES: SOLITUDE/MOMENTUM    DRAWING NUMBER: ST001GENERAL

CURRENT RELEASE

## **Garage**

The ramp door gives you complete access to the RV cargo area. When lowered, the loading ramp allows you to easily load rolling cargo, bicycles, small motorcycles and small vehicles. Use caution when using the loading ramp/door area of your RV. Use the tie downs located in the cargo floor to attach and secure items so they cannot come loose, unfastened, opened or released while the RV is in motion. The cargo area also includes an in-floor storage area for items such as tools.

Do not remove the following labels from the garage area:

 **DANGER**

**ANY MOTORIZED VEHICLE OR ANY MOTORIZED EQUIPMENT POWERED WITH FLAMMABLE LIQUID CAN CAUSE FIRE, EXPLOSION, OR ASPHYXIATION IF STORED OR TRANSPORTED WITHIN THE RECREATIONAL VEHICLE. TO REDUCE THE RISK OF FIRE, EXPLOSION, OR ASPHYXIATION:**

- 1. Do not ride in the vehicle storage area while vehicles are present.**
- 2. Do not sleep in the vehicle storage area while vehicles are present.**
- 3. Close doors and windows in walls of separation (if installed) while any vehicle is present.**
- 4. Run fuel out of engines of stored vehicles after shutting off fuel at the tank.**
- 5. Do not store, transport, or dispense fuel inside this vehicle.**
- 6. Open the windows, openings, or air ventilation systems provided for venting the transportation area when vehicles are present.**
- 7. Do not operate propane appliances, pilot lights, or electrical equipment when motorized vehicles are present.**

**!!! DANGER !!!**

**FAILURE TO COMPLY COULD RESULT IN AN INCREASED RISK OF FIRE, EXPLOSION, ASPHYXIATION, DEATH, OR SERIOUS INJURY.**

AD-98

 **WARNING**

Secure cargo and vehicles as far forward as possible. Excess weight in the rear of this trailer can result in loss of stability when towing.

Consult the trailer Owner's Manual for loading and weighing procedures. Keep the loaded tongue weight between 10% and 15% of total weight for travel trailers, and between 20% and 25% of total weight for 5th wheels.

Move cargo and/or vehicles to maintain proper balance. Do not exceed GVWR (total weight rating) or GAWRs (axle weight ratings) of the trailer or tow vehicle.

AD-115



Typical Mini-Command Center, located in the garage area.



Photo shows typical Happijac® locking pins, with the top bed locked in the highest position

### **WARNING**

RAISE THE REAR BED TO THE HIGHEST POSITION WHEN TOWING YOUR RV. Damage to the rear bed may result from traveling with the bed in the lowered position.

### **WARNING**

DO NOT LOAD MORE THAN 600 LBS. ON THE BED. Damage to the bed lift mechanism and personal injury may result from overloading.

## **Power Bed With Sit and Sleep Sofa**

### Power bed

The Happijac® power bed lift system supports the two beds which can be raised up and out the way while storing or hauling ATV's or other equipment, and lowered again for use when needed.

#### Operating precautions:

- CHECK.... to be sure the locking pins are securely fastened at all 4 corners of the bed platform before towing the RV or using the bed(s).
- ALWAYS.. raise the bed(s) to the FULL UP position when the RV is being towed to avoid damaging the bed(s) as a result of bouncing.
- NEVER.... operate the bed(s) with any items other than bedding on the bed platform.
- NEVER.... travel with any items other than bedding on the beds. Loose items can become projectiles.
- NEVER.... operate the bed(s) when person(s) are on the bed platform.
- ALWAYS.. ensure that the areas above, below and adjacent to the bed(s) are free from obstructions before operating the bed(s).
- ALWAYS.. check before operating bed(s) to ensure bedding is not over-hanging the ends of the beds where it could become entrapped.
- ALWAYS.. exercise care when loading cargo/vehicles in the bed area to avoid damage to the bed mechanism.
- ALWAYS.. properly secure loads in the bed area to avoid damage to the bed mechanism from shifting or falling loads

### To lower the top bunk

To lower the top bunk, press the Bed “Up” control switch. The lower bunk will rise up to the underside of the upper bunk and lift the upper bunk off the four (4) travel pins. **CAUTION: Make sure nothing is sitting on the lower bunk prior to lifting or damage could occur to the underside of the upper bunk.** After the upper bunk is lifted off the pins, pull each of the four (4) pins and store. Press the Bed “Down” switch to lower both the upper & lower bunks. The upper bunk will stop in a preset position. Continue to lower the bottom bunk to the desired position. Reverse this process for raising the bunks for garage clearance and/or travel.

**NOTE: The upper bunk should always be pinned in the upper most position for travel. The lower bunk should be low to the deck floor.**

Do not remove the following label from the bed lift manufacturer:

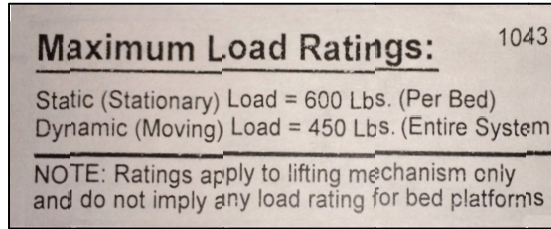

### Sit and sleep sofa

To change the bottom bed into the sofa position the bed must fully lowered. Grasp the center section of the bed and pull it upwards towards you. Push the sofa back towards the outside walls of the cargo area until it clicks, locking it in place. To return it to the bed position, pull forward on the sofa back to release the lock mechanism, and then push it back down into the bed position.

### Ramp Door/Patio Deck

In addition to the information below, also refer to the “How to Set Up the Ramp Door in the Patio Deck Position” guide on the following pages.

#### Ramp door

Be certain the area behind the RV is clear before unlocking and lowering the ramp door. Do not remove the following label located near the ramp door locks:



#### Patio deck

Your unit may be equipped with a patio deck complete with folding rails. Caution should be taken not to exceed the ramp door weight capacities when in either the ramp position or the patio deck position, and to maintain even weight distribution.

To set up the patio deck locate and secure the cables (one on each side of the ramp door) by lifting the ramp door up slightly, then securing each cable end to the ramp door by inserting the safety pin through the bracket and securing the safety clip on the end of the pin. Repeat the process for the cable on the other side of the ramp door.

To set up the side rails, remove the safety pins from the bottom of the rail posts. Lift the rail to the upright position and secure it



Photo shows typical ramp door handle and lockset

## **⚠ CAUTION**

*When returning the ramp door to the stowed position, be sure all safety pins used to secure the rails during transit are in place and secure with the safety clip in place. Failure to do so could result in damage to the rail and ramp door.*

## **⚠ WARNING**

*Maximum capacity is based on an evenly distributed load in the patio position. Failure to observe the weight limit or use other than intended may result in personal injury.*

## **⚠ WARNING**

*The retractable rear awning must be fully closed and locked securely when the RV is in transit.*

in place by inserting a safety pin through each hole in the bracket and the rail. Secure the safety clip on the end of each pin. Repeat the process on all corner rail posts.

Do not remove the following labels from the ramp door manufacturer:

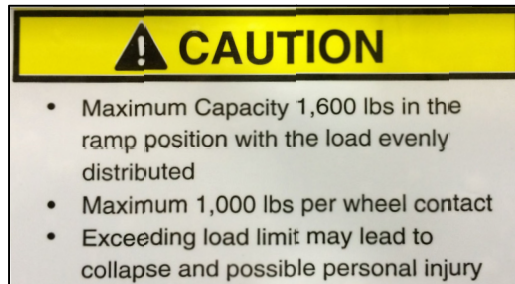

*Follow the above weight label instructions when the ramp door is in the ramp position.*

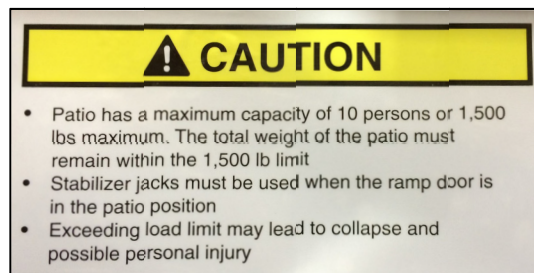

*Follow the above weight label instructions when the ramp door is in the patio deck position.*

### **Retractable Screen Wall**

Make sure that all obstacles are removed from the path of the screen wall. Grip the strap attached to the screen wall pull bar and pull down. Grasp the pull bar and continue pulling the screen wall until it is completely extended. To store the screen wall, pull up on the pull bar handle to release it from the grabber catch and push the screen up until it is fully retracted.

To avoid damage to the screen wall and possible injury, make sure it is fully extended and snapped in place at the floor when in use and fully retracted when not in use.

### **Retractable Rear Awning**

Refer to the "How to Set Up the Garage Retractable Rear Awning" guide on the following pages.





# MOMENTUM

## How to Set Up the Ramp Door in the Patio Deck Position\*

\*Read and follow all warning and caution labels before starting



1. Unlock and open the ramp door locks.



2a. Carefully lower and open the ramp door making sure both ramp door cable ends are fastened securely...



2b. ...by the safety pin at the ramp door bracket as shown above.



3. The opened ramp door should look similar to the above photo.

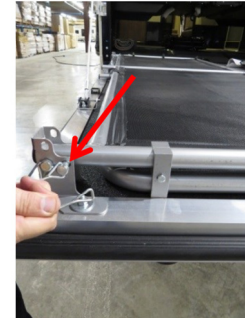

4. Remove the right most side locking safety pin as shown from the front & rear brackets.

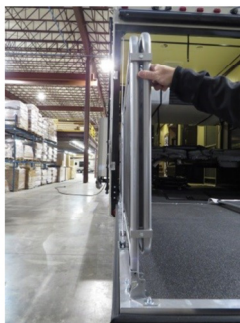

5. Carefully lift and swivel the side patio gates to the vertical position.



6. Insert the safety pin (removed in step 4) to the topmost position as shown to secure the side patio gates vertically.



7. Remove the velcro straps (TIP: re-wrap them on the gates to ensure they aren't lost) that secure the end patio gates shut in the travel position.



8a. Swing the patio end gates to the open position, fitting them in the holder as shown...



8b. ...then screw the top and bottom locks in as shown to secure the end gates in the closed (locked) position.



9. Lastly, slide on and fasten the fabric side protectors as shown.

# MOMENTUM

## How to Set Up the Garage Retractable Rear Awning\*

**\*Read and follow all warning and caution labels before starting**



1. Locate the turning mechanism located on the rear awning, then insert & rotate the awning handle to manually extend the awning. Stop when the awning is fully extended.



2. Locate both orange colored locking mechanisms at the top inside of the extended awning, and pull the handles towards you (as shown above) to release the retractable legs.

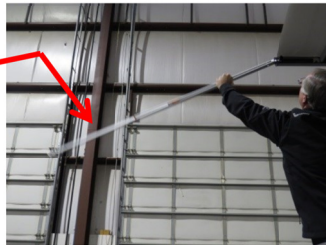

3. Next, push the orange colored handles outwards to release the retractable legs (Tip: rotate the retractable legs downwards as you push the handles out, as shown above).

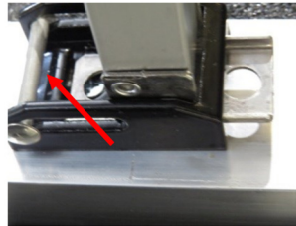

4. Insert the forward side of each retractable awning leg foot into the bracket first as shown above, then roll the pin forward over the rear edge of the foot (Tip: the pin locks the awning foot into the bracket).



5. Finally, adjust the awning height, and slide the orange colored lock to secure each vertical awning leg in place as shown above.

### **WARNING**

*Reverse these steps to store the rear awning back into the travel position. The awning must be stored in the travel position when the RV is in transit, and should be stored in the travel position if you will be away from your RV for an extended period of time to prevent potential damage caused by unforeseen weather conditions.*

## **Interior**

### **Cleaning the Interior**

To keep the value of your RV, perform regular maintenance using the proper materials and procedures. Using the wrong cleaner may result in damage to the surfaces in your RV. Check the component manufacturer's information for the recommended cleaning agent. If in doubt, check to see if the cleaner will cause damage by testing a small area out of sight or contact your dealer for assistance. Do not use flammable liquids or sprays to clean your RV.

### **Recliner Sofa or Loveseat**

Like a residential recliner, the recliner sofa or loveseat sections have controls allowing you to recline the individual sections. To revert each recliner section back to the upright position, gently apply pressure to the recliner leg rest. Refer to the furniture manufacturer's care instructions for this product.

### **Free-Standing Table & Chairs**

The extendable free-standing dinette table can be positioned to seat up to four people. To prevent damage, the standard free-standing dinette table should be closed in the travel position and the free standing chairs fastened down securely when you are traveling.

### **Furniture Upholstery**

To retain the value of your RV, maintain the furniture upholstery carefully and keep the interior clean. Vacuum the furniture regularly using a soft brush attachment to remove any loose dirt or debris.

#### **Fabric upholstery**

It is recommended the fabric be professionally cleaned if it becomes stained or soiled. For more information, refer to the specific furniture manufacturer's care instructions.

#### **Suede upholstery**

It is recommended the suede be professionally cleaned if it becomes stained or soiled.

#### **Vinyl upholstery**

Do not dry clean vinyl components. If they are dry cleaned, the vinyl on the reverse side will shrink, become hard and crack. If a spill does occur water base cleaners are recommended (solvents are not recommended as they may have an adverse reaction to the specific backing of your upholstery fabric). Blot up the spot, but do not rub it in or saturate the area. Use a professional furniture cleaning service for an overall cleaning.



*Some, but not all, recliner loveseats have storage in the middle armrest.*



*Your free-standing dinette chairs may have hidden storage (to access the storage area lift the seat cushion)*

Clean the suede or vinyl upholstery only as recommended. Using other processes than those listed may produce undesired results and possibly damage the upholstery. This type of damage is not warrantable.

### **Decor Items**

#### *Window treatments, curtains, blinds and shades*

Dust occasionally with a vacuum and soft brush attachment. Professionally clean only.

#### *Decor glass*

Use a glass cleaner to remove smudges, smears and spots. If there is any decorative etching on the décor glass, use care when cleaning around that area.

### **Pantry**

Use the pantry to store items you wish to take with you as you travel and camp. Ensure items stored in the pantry are secured so they do not shift during travel. The cabinetry has been designed to accommodate the normal camping items (i.e., paper plates, flatware, cookware, etc.) which are bulky but not necessarily heavy.

**Remember your RV's load capacity is designed by weight, not volume, so you cannot necessarily use all available space.**

### **Paneling**

To clean, use a mild solution of soap and lukewarm water with a soft sponge or cloth. Do not use abrasive cleaners as they could cause the vinyl to scratch and turn dull. Grease spots and stubborn dirt can be cleaned off with an all-purpose spray cleaner. Harsh cleaners and organic solvents can attack the printed vinyl; they are not recommended.

### **Cabinetry & Tables**

To keep hardwood doors, cabinet fronts and hardwood tables looking like new regularly dust with a soft cloth dampened with a cleaning polish or mild detergent solution. Avoid using ammonia based products or silicone oils as they may cause damage if used over a long period of time.

The finish is durable and resistant to most household spills. However, spills should be wiped up promptly to avoid potential problems. Excessive prolonged exposure to direct sunlight, high temperatures and high humidity can cause damage to both the finish and the wood itself. These should be avoided.

## **Countertops**

To prevent permanent damage:

- Always use hot pads or trivets under hot pans, dishes, or heat producing appliances such as frying pans.
- Always use a cutting board; never use a knife on the countertop.
- Avoid harsh chemicals such as drain cleaners, oven cleaners, etc.
- Do not let cleaners with bleach set on the top. Wipe them off promptly.

### *Laminate countertops*

Glass rings, food spills, water spots and smudges usually wipe off with a damp sponge. Stubborn stains can be removed with a general-purpose spray cleaner. Some stains can be removed by squeezing fresh lemon juice over the stain and allowing the juice to soak for approximately forty-five minutes. After 45 minutes, sprinkle baking soda over the lemon juice and rub with a soft cloth.

### *Solid surface countertops*

Solid surface materials are easy to care for. Soapy water, ammonia based cleaners (not window cleaners as they can leave a waxy build up that may dull the surface) or commercially available solid surface cleaners will remove most dirt and residue from all types of finishes. A damp cloth followed by a dry towel will remove watermarks. Disinfect the surface periodically with diluted household bleach (one part water to one part bleach). For additional information on the removal of difficult stains or surface damage repair, refer to the countertop manufacturer's user guide.

## **Flooring**

Always test a cleaning agent in an inconspicuous area for colorfastness.

### *Carpet*

Vacuum regularly with a vacuum cleaner with a revolving brush or beater bar. Be sure the vacuum does not have teeth, combs or rough edges as they may damage the carpet. It is important to remove loose soil and debris while it is on the surface. Heavily traveled areas (i.e., walkways, areas in front of the furniture) may be protected with small throw rugs to prolong the life of the carpet.

Some spills contain chemicals that will destroy carpet fibers and dyes. If you have doubts about what caused the spot, contact a professional carpet cleaner. Because of the additional dirt typically associated with camping, we recommend that you vacuum the carpet frequently. Have tough and deep stains

professionally steam cleaned. Use spot removers for minor spills. Always test the carpet for color fastness in an inconspicuous area before using any product.

#### Vinyl flooring

Periodically vacuum or sweep to remove dirt and gritty particles. Although most common spills will not permanently stain the vinyl floors, they are usually easier to remove if wiped up before they set. Simply blot with a paper towel and wipe clean with a damp cloth. As part of a regular maintenance program, sponge mop the entire floor. Do not use dish detergents or vinegar and water because they will dull your floor.

To care for the vinyl floor covering, use a damp mop with water and a mild cleaner. DO NOT SOAK THE FLOORING. Use care to avoid wetting the carpet edges. To avoid problems of “yellowing” linoleum, avoid cleaners that contain oil based solvents (i.e. cleaners containing lemon oil, Murphy’s Oil Soap, etc.).

#### ABS Plastic

ABS plastic components will retain their original beauty with reasonable care. Dust and wipe clean with soft, damp cloth or chamois, wiping gently. Do not use gritty or abrasive particle soaps or scouring compound to clean ABS plastic. Avoid using “Citrus” or biodegradable cleaners which contain “D-Limonene” as they may damage plastic materials.

#### Fiberglass Shower Walls

Use a mild detergent soap and warm water to clean the fiberglass shower wall. DO NOT use gritty or abrasive particle soaps or scouring compound to clean the fiberglass.

#### Sink & Shower Fixtures

Use mild dish soap and water to clean these fixtures. Do not use harsh chemicals or sprays. A mild solution of vinegar and water works well to remove hard water spots and stains from the sink or shower fixture

## **Exterior**

### **Cleaning the Exterior**

To protect your RV's exterior finish, wash it often and thoroughly. Regular cleaning and waxing will help protect the exterior. If chalking occurs, wash and try to wax a small area to see if the luster returns. If the exterior becomes scratched, nicked or cracked have your dealer inspect the RV. Your RV is exposed to many environmental conditions that have an adverse effect on the paint finish:

- Road Salt and Sodium Chloride
- Road Tar / Bugs
- Bird Droppings / Tree Sap
- Industrial Fallout / Acid Rain /Pollution
- UV Exposure and Moisture

The most common problems resulting from these conditions are corrosion, staining, and chemical spotting. Generally, the longer the foreign material remains in contact with the exterior finish, the more extensive the damage. These problems can be minimized by regularly scheduled washing and polishing.

The RV exterior is constructed of plastics, glass, sealant, aluminum and/or fiberglass. Refer to the general instructions that follow for care information

#### **Washing**

Chemicals contained in dirt and dust picked up from the road surface can cause damage if left on the RV for a long time. Frequent washing and waxing is the best way to protect your RV from this damage. Frequent washings also protect your RV from environmental elements, such as rain, snow and salt air.

Wash your RV as soon as possible if it becomes contaminated with foreign material. Avoid parking under trees or near ocean sea salt. Do not scrape ice or snow from the painted surface, brush the affected area off! If anti-freeze, gasoline or washer solvents get spilled on the painted surface, rinse the area off with water immediately. Bugs and bird droppings should be rinsed off daily.

We recommend that you do not take your RV through automatic car washes. Extreme caution should be used if utilizing any type of pressure sprayer around all attachments, doors, windows, appliance vents, etc. Avoid forcing water inside the RV, which could possibly damage component parts.

Do not wash the RV when it is in direct sunlight. Park the RV in the shade and spray it with water to remove dust. Next, using

an ample amount of clean water and a car-washing mitt or sponge, wash the RV from top to bottom. Use a mild car-washing soap if necessary. Rinse thoroughly and wipe dry with a chamois or soft cloth. Carefully clean the joints and flanges of the slideout, doors, hood, etc., where dirt is likely to remain.

Some types of hot water washing equipment apply high pressure and heat to the RV. They may cause heat distortion and damage to the resin parts and may flood the RV's interior. Therefore, be sure to observe the following:

1. Keep the washing nozzle about 16 inches (40 cm) or more away from the RV body.
2. When washing around the door, vent and glass areas, hold the nozzle at right angles to the surface.

#### During cold weather

Salt and other chemicals that are spread on winter roads in some geographical areas can have a detrimental effect on the RV's underbody. If your RV is exposed to these conditions, spray the underbody with a high-pressure hose every time you wash the exterior of your RV. Take special care to remove mud or other debris that could trap and hold salt or moisture. After washing your RV, wipe off all water drops from the rubber parts around the slideout and doors.

If the slideout or door is frozen, opening it by force may tear off or crack the rubber gasket that is installed around the slideout or door. Pour warm water on the gasket to melt the ice (wipe off the water thoroughly after opening the slideout or door). To prevent the weather stripping from freezing, treat it with a silicone spray.

#### Waxing your RV

Wax your RV once or twice a year, or when painted surfaces do not shed water well. Use a soft cloth to apply a small amount of wax to the painted surfaces. After the wax has dried, polish the RV with a dry, soft cloth. Do not wax your RV in direct sunlight. Wax it after the surfaces have cooled. Do not apply wax to any area having a flat black finish as it can cause discoloration. If the finish has been stained with wax, wipe off the area with a soft cloth and warm water.

When waxing the area around the various openings, do not apply any wax on the weather strip. If it is stained with wax, the weather strip cannot maintain a weatherproof seal around the opening.

### **CAUTION**

*Do not use waxes containing high-abrasive compounds. Such waxes remove rust and stains effectively, but they are also harmful to the luster of the surface, since they may scrape off the coating. Further, they are detrimental to glossy surfaces, such as the grille, garnish, moldings, etc. Do not use gasoline or paint thinners to remove road tar or other contamination to the painted surface.*



### Cleaning plastic parts

Use a sponge or chamois to clean plastic parts. Use warm water and a soft cloth or chamois to remove any white residue from dark colored plastic surfaces. Do not use a scrubbing brush or other hard tools as they may damage the plastic surface. Do not use wax containing abrasives that may damage the plastic surface.

### Chrome parts

To prevent chrome parts from spotting or corroding, wash with water, dry thoroughly, and apply a non-abrasive automotive wax. If the chrome is severely damaged or pitted, use a commercially available chrome polish product.

### Exterior Roof & Sidewall Vents

Dicor Products recommends that a rubber roof be cleaned at least four times annually. Use the following steps:

1. Completely rinse your roof with clean water to remove any loose dirt or debris.
2. Use a medium bristle brush and a concentrated cleaning agent such as Dicor Products RP-RC160C, mixed with two or three gallons of water. As an option to the concentrated cleaning product, Dicor also has a ready-to-use roof cleaner: RP-RC320S. Work in small manageable sections such as a 3' X 3' area starting at one end and working toward your point of exit. Scrub and rinse with clean water thoroughly to avoid residue build-up on the roof or sidewalls of your RV.
3. For difficult areas, repeat step 2.

While you are cleaning the exterior roof, also inspect the roof vents (including sealants) for cracks and keep them clean. Inspect the refrigerator and holding tank vents for blockages from bird nests, spider webs, leaves, etc.

Water heater, furnace and refrigerator exterior doors need to be kept clean and free of obstructions (i.e., insect nests, mud daubers, etc.) while the appliances (if so equipped) are in use.

### Windows

Any ventilating window may permit water inside, especially during heavy rainstorms. Condensation will also cause water to accumulate on windows and in the tracks. The window "glass" can be cleaned normally with a sponge and water. Use glass cleaner to remove wax, oil, grease, dead insects, etc. After washing the glass, wipe it dry with a clean, soft cloth.

### Trailer Frame

Sand, pebbles, objects on the highway, climate (salt air exposure) or ice inhibiting chemicals used during the winter

### **CAUTION**

*Do not use a buffer and a buffing compound as it may damage the exterior surface. Please contact a professional paint body shop for assistance*

### **CAUTION**

*Do not allow plastic to come into contact with brake fluid, engine oil, grease, paint thinner, or battery acid. These will damage plastic. Use a soft cloth and a mild detergent solution to wipe away any such contact.*

### **WARNING**

*As with the surface of any roof, a rubber roof can be very slippery, especially when wet. If you go up on your roof we recommend extreme caution and suggest that you navigate the roof on your hands and feet. This distributes the weight more evenly and helps reduce the possibility of falling.*

### **CAUTION**

*Do not use petroleum distillates to clean the roof as they may cause permanent damage.*

## **CAUTION**

*Do not add items to the RV rear bumper. Add-on items will eventually damage your bumper. Damage caused by such aftermarket equipment installation or improper loading voids the Limited Base Warranty and Limited Structural Warranty.*

## **WARNING**

If your RV is equipped with a roof ladder, do not leave items attached to it while traveling. The ladder has a weight limit of 300# when using it to access the roof. DO NOT exceed this weight limit.

## **WARNING**

*The roof ladder must be locked in the closed (travel) position when the RV is in transit.*

## **CAUTION**

*Failure to properly maintain or reseal your RV may result in serious water damage to the roof and other parts of the RV. This damage is not covered by the Limited Base Warranty and Limited Structural Warranty.*

months will damage the paint, inviting rust and other deterioration. Periodically inspect the exterior exposed areas, clean and repaint the frame members occasionally and whenever you notice rust or paint chipped away, to insure protection.

### **Rear Bumper**

The rear bumper of your RV is not designed to carry cargo. Items that extend beyond the bumper will place undo strain on the bumper. Over time, weight added to the bumper will cause damage from the motion created while traveling. In addition, extra weight behind the axle may reduce the hitch weight (leading to adverse handling conditions from wind gusts and/or passing traffic).

### **Roof Ladder**

Your RV may be equipped with an optional roof ladder. The RV roof has decking under the rubber roof membrane to allow you to walk on the roof (with caution) to do maintenance.



*Photo shows typical roof ladder with locking pins in the closed (travel) position.*



*Photo shows typical roof ladder extended for normal use when the RV is parked*

To operate the ladder, pull the locking pins to release the ladder. Then pull the ladder out towards you. The ladder must be fully extended in the outmost position before you attempt to use it. When you are ready to travel, reverse these steps. The ladder must be locked in the closed (travel) position when the RV is in transit.

### **Sealant**

Sealants perform a very important function and should be inspected closely and regularly maintained. We incorporate many different types of sealants, including butyl/putty, black butyl-encapsulated foam, silicone (clear and colored), roof sealant and foam. In general, sealants do not have "set" lifetimes. Varying environmental factors affect the pliability and adhesiveness of sealants. You or your dealer must:

- Inspect all sealants, a minimum of every six months. Make sure to check the roof and all four sides of the RV including all moldings, doors, vents and exterior attachments. A quick walk around the RV before leaving may help prevent potential problems during trips and vacations.
- Have the sealant replaced if you notice any cracks, peeling, voids, gaps, breaks, looseness or any sign of physical deterioration. Reseal at least one time each year as preventative maintenance. Always use the same type of sealant that was removed. Your dealer service or parts manager can help you obtain the correct sealant(s).

The sealants may become damaged due to ultraviolet exposure, air pollution, freezing temperatures and exposure to other elements. If deteriorated, repair immediately to prevent damage. If you notice water inside the RV, immediately have the dealer check for the source of the leak. Failure to correct the leak may result in serious damage to your RV; this damage may not be warrantable. If you have questions and/or need assistance with sealing your RV, consult with your RV dealer.

### **RV Storage**

Properly preparing your RV for storage during periods of non-usage will prevent problems from arising. It will also make it easier to get started again for the following camping trip or season. To prevent costly freeze-ups, winterize the plumbing system when it will not be in use for an extended period of time, especially if it is stored in colder climates.

Periodically inspect your RV for damage during storage, and seal off any area that can offer an entry point for rodents, birds or insects. When storing your RV, it is recommended that the auxiliary battery (customer supplied) be disconnected to avoid battery discharge.

#### Prior to Storage

**If storing for the winter, be sure the RV is winterized.**

- Check your roof and other surfaces to ensure there is no damage and potential leakage that might otherwise go unnoticed until it is too late.
- Close all windows and roof vents.
- Turn off 12-volt DC/120-volt AC/propane to the refrigerator; defrost and clean.
- Use crumpled newspaper or open boxes of baking soda in the refrigerator to eliminate odors during storage.
- Close the propane cylinder valve(s).
- Cover all external outlets, such as furnace, exhaust, etc. to prevent mice or other rodents from entering.

Cover the roof air conditioner (if so equipped).



*Damage from birds, rodents, insect, etc., is not covered under the Limited Base Warranty and Limited Structural Warranty applicable to your RV.*

### **⚠ CAUTION**

*Excessive snow, 8" or more, or ice, 2" or more, places excessive weight on the RV roof. Remove excessive snow or ice as needed. Care **MUST** be exercised to not damage the roof material when removing snow & ice. Excessive weight can damage the roof, seals, etc. Water leaks and poor fit or operation are the results of this damage.*

- 
- Disconnect 120-volt AC power to the RV.
- Do not use the leveling legs during storage.
- Drain all water lines.
- Drain and flush all holding tanks (fresh water, gray water, black water and/or hot water tanks).
- Remove all batteries from the RV and store in a place where they will not freeze. Batteries that have been frozen will never hold a proper charge.
- Thoroughly wash the interior and the exterior of your RV.
- Store your RV indoors, under a roof or purchase a “breathable” cover for use during storage.
- To prevent weather checking and other UV damage, cover tires that are exposed to sunlight.

*During Storage Period*

Remove snow from the top of your RV to prevent damage to the unit’s structure.

REQUIRED MAINTENANCE SCHEDULE								
Maintenance Item	Every Trip	Monthly	Every 3 Months	Every 6 Months	Annually	Before/After storage	As Required	Procedure To Be Performed: Maintenance schedules are minimum requirements. Extended use, extreme temperatures, high humidity or other extreme conditions will require more frequent maintenance.
Appliances					X	X		Check settings & adjustments per manufacturers guide
		X				X		Make sure burner tubes/vents are clean/unobstructed
					X	X		Clean & sanitize
Awning(s)						X		Wash with warm water & mild detergent
					X	X		Clean & lube moving parts w/WD40
Axles/Suspension						X		Check U-bolts, springs & hangers for damage
					X	X		Check torque - all bolts (see axle MFG. guide for specs)
Baggage Doors		X				X		Confirm that doors seal tight and are not leaking
				X		X		Spray lock tumblers with dry graphite
Brakes/Wheel Hubs					X			Check amp draw/shoe wear/adjustment (see MFG guide for specs)
					X		X	Lube bearings (as needed)
Electrical System	X		X			X		Check and service batteries
			X		X	X		Test all GFI outlets
					X	X		Service generator (if equipped) per MFG manual
Entry Door(s)	X					X		Make sure door latches & locks function properly
				X		X		Lube hinges w/light oil or WD40 (or comparable)
				X		X		Adjust screen door and latch
Entry Steps				X		X		Clean and lubricate (lithium spray)
Exterior Fiberglass/Metal			X			X		Wash with warm water & mild detergent
				X				Apply non-abrasive wax (except on decals)
Exterior Moldings			X			X		Inspect sealant for voids/gaps/cracks & reseal
Frame/Underbelly					X	X		Check for damage, loose wires, debris, etc. & clean
			X			X		Check frame for rust and touch up as necessary
Hitch/Coupler					X	X		Check for damage & wear - clean & lubricate (grease)
LP System					X			Have system tested for leaks by qualified dealer
					X			Have pressure & regulator setting checked by dealer
Plumbing System			X		X	X		Check hoses, fittings, pipes for leaks - tighten as req.
					X	X		Lubricate termination gate valve cables (WD-40 or Lithium grease)
					X			Winterize system (cold weather locations)
Roof & Roof Attachments			X			X		Inspect for sealant for voids/gaps/cracks & reseal
				X		X		Clean roof w/water & mild detergent
					X	X		Clean & lube roof vent mechanisms w/light oil
Safety Equipment	X			X		X		Check operation of detectors - R&R batteries every 6 months if equipped.
				X	X			Test & check fire extinguisher for proper charge
	X	X			X			Test and confirm egress (exit) windows function properly
Slide Rooms			X		X	X		Check slide roof for debris - clear
			X		X	X		Check and clean all seals
Wheels & Tires	X		X			X		Check wheel lugs for proper torque
			X			X		Inspect tires for wear/damage/etc.
	X		X			X		Check tire inflation pressure (see tire label for pressures)

### **Suggested Maintenance Checklist**

This list is a quick reference sheet for suggested areas of regular maintenance. Review all manufacturer's operators manuals supplied with your RV to perform these listed maintenance items.

#### **Prior to First Trip**

- Inspect and reseal as needed.
- Have the propane system checked for leaks by your dealer.
- Check wheel lug nuts at specified intervals to listed torque specifications, re-torque as needed.
- Sanitize the fresh water system.
- Test the safety alarms.

#### **First Two-Hundred Miles**

- Check wheel nuts at specified intervals to listed torque values. Re-torque as needed.
- Have brakes adjusted by a qualified service technician.

#### **Each Trip**

- Inspect and reseal as needed.
- Check the auxiliary battery. Have the propane system checked for leaks by your dealer.
- Check running lights.
- Check tire pressure and wear, including spare. Make sure the tires are cold when checking the tire pressure.
- Check wheel nuts at specified intervals to listed torque values. Re-torque as needed.
- Flush out water heater tank.
- Test brakes.
- Test safety alarms.

## **Basic Troubleshooting**

### *Electrical Power*

#### *No AC power to RV*

- Check circuit breakers at power center. The 120-volt circuit breaker may be off or tripped.
- Have a dealer check that there is power to the shoreline receptacle.

### *Furnace*

#### *Furnace does not ignite and/or cycles frequently*

- Check that propane tank is full.
- Remove any obstruction over furnace exhaust.
- Inspect exhaust tube for any obstructions.
- Check fuse in fuse panel and replace if necessary.
- Make sure that return air grill is unobstructed. Remove anything that is stored in furnace compartment that could block airflow.
- Check that heat outlet registers are open and that register openings are unobstructed.
- Make sure that 12-volt power is present.
- Contact your dealer if the problem persists.

### *Generator (customer supplied)*

#### *Starter engages while holding the start button down, but generator does not start*

- Generator may be out of fuel. (Generator will not operate when the fuel tank is less than ¼ full).
- Generator may be low on oil. Check the oil level.

#### *Nothing happens when the generator start button is pushed*

- Check that the battery disconnect switch button is pushed.
- Check 12 Volt fuse on generator.
- Reset circuit breaker if necessary.
- Contact your dealer or a qualified RV technician if problem is not resolved,

#### *Generator starts, but lacks electrical power*

- Breaker switches may be off or tripped at generator. Reset breaker if necessary.
- Breaker may be off or tripped inside power center. Reset main breaker if necessary.

#### *Generator makes clicking sound when trying to start*

- Battery condition may be low. Recharge if necessary.
- Check for poor ground or battery connection.

### **WARNING**

*Turn thermostat and furnace gas control valve off and contact your dealer or authorized service center. DO NOT attempt to repair or adjust the furnace yourself.*

### Interior Lights

#### *Lights flicker*

- Loose or defective bulb. Tighten or replace as needed.
- Converter is overheating. Open the cover to cool down and reduce the load by turning off some 12-volt lights.

#### *Lights dim or are half bright*

- Low battery connection. Check battery condition and recharge if necessary.
- Possible converter malfunction. Have converter checked by an authorized service center.
- Possible loss of ground. Check for loose wire connection.

### Microwave

#### *Will not operate*

- Door open or timer OFF. Close door and turn timer ON.
- No power to oven. Check power supply and circuit breaker.

### Monitor Panel

#### *No lights on panel when switch is pressed*

- Check battery voltage and condition.
- Check fuse at the battery; if fuse is good have a dealer or qualified RV technician check the condition of panel.

#### *Holding tank lights deliver false readings (i.e. 1/3 or 2/3 indication)*

- Verify tank is empty.
- Debris may be built up across probes. Clean and flush tank using four parts vinegar mixed to two parts water.

#### *Propane indicator display indicates E or F all the time*

- Ensure propane gas tank is full.
- If display is F, check the wiring or sending unit for malfunction.
- Have it inspected by a certified technician.

### Outside Receptacle

#### *No power to outside receptacle*

- Make sure you have power to the shoreline.
- Check breaker on generator.
- GFCI receptacle switch may be off or tripped. Re- set GFCI at receptacle in bathroom or kitchen.
- Check the breaker in the power center or panel box.
- Contact a dealer or qualified RV technician if problem is not resolved.



Oven

*Oven slow to heat up*

*Poor baking*

*Poor ignition of burners, pilots won't stay lit*

*Popping sound from top burners, carbon on pilot shield*

*Burner flame too low or too high*

- A defective gas pressure regulator may cause these conditions. Have the regulator tested by your gas dealer or a certified RV technician.

*Top burner or oven burner won't light or won't stay lit*

- Check position of top burners and flash tubing.
- Clean clogged burner ports with a toothpick.
- See Oven Owner's Manual for proper care and maintenance.

*Gas smell*

- Check all connections with leak detector solution.

*Food burns on the bottom*

- Oven too full for proper circulation. Use smaller pans or put less food in the oven.

Propane Gas

*Smell gas in or around unit*

- Propane tanks may be overfilled.

*Follow these instructions:*

- Extinguish any open flames, pilot lights and all smoking material.
- Do not touch electrical switches.
- Shut off gas supply at the tank valve or gas supply connection.
- Open doors and other non-powered venting openings.
- Leave the area until odors clear.
- Have the gas system checked immediately and leakage source corrected by your dealer or a qualified service center before using again.

Refrigerator

*The control panel lights are not illuminated*

- Check coach circuit breakers and GFCI receptacle.
- Verify that refrigerator is plugged into the 120-volt outlet.
- If using propane gas, verify house batteries have adequate charge.

*Lights are illuminating, but no cooling*

- Use a proper power source that is available and cooling operation to specification.
- Make sure the refrigerator unit is level.

**⚠ WARNING**

*Never use a match or flame to check for propane gas leaks. Failure to follow this warning could result in a fire or explosion resulting in serious injury or death.*

**⚠ WARNING**

*All propane connections should be checked periodically as vibrations from travel may cause them to loosen. Failure to check connections could lead to a leak of propane, resulting in a fire or explosion that could cause serious injury or death.*

**⚠ WARNING**

*Working with propane can be dangerous. Always have your dealer or certified professional perform all repairs to your LP system.*

### **WARNING**

*Extinguish all flames. Never use a match or flame to check for leaks. Failure to follow this warning could result in a fire or explosion resulting in serious injury or death.*

### **WARNING**

*Working with electrical appliances can be extremely dangerous. Always have your dealer or a certified professional perform all repairs to your appliance and/or RV electrical system.*

- Allow sufficient time for proper cool down and try to load with pre-cooled food.
- Have a qualified RV technician check that the vents and chimney at the rear of the refrigerator are clear and unobstructed.
- Have a qualified RV technician make sure the burner jets or burners are not dirty or damaged.
- Have a qualified RV technician check the fuses in the black electrical box on the rear of the refrigerator.

#### *Heavy frost build up on the evaporator fins*

- Defrost the freezer and refrigerator.
- Have the refrigerator checked by your dealer or a qualified RV technician.

#### Roof Air Conditioner

##### *Will not operate*

- Make sure unit is turned on.
- Check circuit breakers in coach.
- Have your dealer check to see if there is proper voltage from shoreline or generator.

##### *Unit runs, but coil freezes and compressor cycles too soon*

- Control setting may be too low, cycles too soon.
- Make sure the filter is clean and unobstructed.
- Have the coolant level checked by a qualified service facility.

##### *Does not get cold enough*

- Start the unit before the day gets too hot.
- To offset heat gain:
  - Close all windows and blinds.
  - Keep entrance doors closed.
  - Use awnings.
  - Avoid using heat-producing appliances.
- Make sure the outside coil is not blocked or damaged.
- Have your dealer check to make sure you have the proper voltage.
- Should your air conditioner still not work after the above checks have been made, contact a qualified service facility to perform more extensive testing.

#### Running Lights

##### *Running lights not working*

- Blown fuse. Replace fuse with one of the same ampere rating.
- Bad bulbs. Replace the bulbs with new.

### Slide-Out

*Room move in and out very slowly, binds or squeaks*

- Lubricate the slide-out tubes and rollers with light spray lube.

*Water is getting in at the bottom corners of the room*

- Verify exterior seals are against the room at the top corners and not turned in when the room is out (horizontal seal overlaps vertical). Also, check for voids in the seal on the slide roof and side panels.
- Make sure weep hole in ramp pan is open and unobstructed.

*Room will not move in or out*

- Check the auto-resetting fuse located by the slideout motor. (See the manufacturer's manual).
- Check battery condition and state of charge. Recharge if necessary.

*Rollers leave tracks in the carpet as the room extends*

- This is normal. There are many pounds of weight pressing these rollers down on the carpet and rollers will compress the nap of the carpet down. Raking the nap or vacuuming will solve the problem.

### Termination Valve

*Termination valve leaks*

- Debris keeps valve from seating. Clear debris from and around valve O-ring set.
- Bad gasket. Have your dealer or qualified RV technician replace gasket with new.

### TV Antenna

*Poor TV reception*

- Power jack is not turned on. Turn power jack switch to ON.
- Bad connections at TV or wall plate. Make sure the connections are good at both TV and wall plate.
- Antenna not pointed in direction of sending station. Point antenna in proper direction.
- Cut or torn cable. Have your dealer or qualified RV technician replace bad cable where needed at TV and antenna.

*Elevation handle turns, but antenna does not raise or lower*

- Handle may be loose. Tighten screws.
- Gears may be stripped. Have your dealer or qualified RV technician replace the gears.

*Antenna will not rotate*

- The rotate handle is engaged to the ceiling plate.
- Pull down on handle to disengage from the ceiling plate.

- Possible obstruction (tree branch, etc.). Remove the obstruction.
- Friction adjustment. Adjust center lock nut.
- Check to make sure roof sealant is not restricting rotation.

### Waste Tank

#### *Waste tank (black) will not drain*

- Buildup or debris in tank. Check for buildup in tank at stool.
- Always use a minimum amount of biodegradable toilet paper.
- Always use plenty of water when flushing.
- Check termination valve for proper operation.

### Water Heater

#### *Temperature-pressure relief valve weeping*

- Weeping or dripping of relief valve while water heater is running does NOT mean it is faulty.

#### *There is an odor that smells like rotten eggs*

- If your fresh water source has a rotten egg odor, you will need to find another source of fresh water before flushing or refilling the entire RV water storage system. To remove the hydrogen sulfide (rotten egg) odor:
  - Turn off your main water supply; that is your pump or your water hookup source.
  - Drain your water heater tank by removing the drain plug. Approximately two quarts of water will remain in the bottom of the tank. If you notice during the draining that the water is flowing sporadically or slowly, instead of flowing freely, you should open your relief valve to allow air into the tank.
  - If the water does not flow freely, take a small gauge wire or coat hanger and push through the drain opening to eliminate any obstructions.
  - After thoroughly draining the tank, flush the entire system from the water inlet all the way to the holding tank. To flush, use four parts vinegar mixed with two parts of water. If you decide to use air pressure (55 PSI max.), it may be applied either through the inlet or outlet on the rear of the tank. It may also be applied through the relief valve port. In this case, it will be necessary to first remove the relief valve. You may then insert your air pressure through the relief valve support flange. In either case, with the drain valve open, the air pressure will force the remaining water out of the tank. If air pressure is unavailable, you may flush your tank with fresh water. Fresh water should be pumped into the tank with the assistance of the on board water

- pump or with the assistance of external water pressure. Once again, external pressure may be pumped into the unit either through the inlet or outlet found on the rear of the water tank, or using the relief valve inlet located on the front of the unit.
- Continue this flushing process for approximately five (5) minutes allowing ample time for the fresh water to agitate the stagnant water on the bottom of the tank and force the deposits through the drain opening.
- Upon completion of the steps above, close the drain plug as well as the relief valve. Refill with fresh water, circulate and rinse.
- If you use your vehicle frequently or for long periods of time, flushing the water heater several times a year will prolong the life of the water heater storage tank.

*Water heater will not fire up*

- Check for obstructions in burner tube and exhaust.
- Check 12 Volt power for possible blown fuse.
- Bad circuit board. See your dealer.

Water Pump

*Pump will not start*

- Check that house battery disconnect switch is on.
- Check pump switch at monitor panel.
- Check fuse in power center.
- Check to see if water is frozen.

*Will not prime, sputters (no discharge, but the motor runs)*

- Check to see if there is water in the tank, or if air collected in the hot water heater.
- Check for frozen water lines or water tank.

*Pump will not shut off, runs when faucet is closed*

- Turn off the pump or city water supply.
- Check for damp areas around plumbing appliances.
- Check plumbing for leaks and inspect for leaky valves on toilet.
- Have the pump checked by your dealer or a qualified RV technician.

Water System

*Wet areas near water connections, pump runs while the faucets are closed, and no other fresh water fixtures are being used*

- There is a possible leak,
- Close all low point water drains and tank drains.
- Turn off all fixtures.
- Check all fixtures and connections for tightness.
- Do not over tighten fittings as this may cause additional leakage.

This page is intentionally blank

## **Glossary of Terms**

**AC ELECTRICITY** – Alternating current also known as shoreline power. For purposes of this manual, it refers to 120-volt AC (abbreviated 120 VAC).

**AMP** - Short for ampere, the electric current unit of measure. RV sites with electric hookup will specify the maximum amps supported, which generally come in units of 20, 30, or 50 amps. The RV power connector must match the various plugs of the site amp rating.

**ANODE ROD** - An anode rod, when used in a water heater, attracts corrosion causing products in the water. These products attack the anode rod instead of the metal tank itself. The anode rod should be inspected yearly and changed when it is reduced to about 1/4 of its original size. The rods are used in steel water heater tanks - an aluminum tank has an inner layer of anode metal to accomplish the same thing. Anode rods should not be installed in aluminum tanks!

**AUXILIARY BATTERY** – For purposes of this manual, the term refers to the 12-volt DC group 27 deep cycle battery (customer purchased) that should be installed in your RV.

**AWNING** - A roof-like structure made of canvas or other artificial materials which extends from the RV body to provide shade. Awnings are generally placed over entrances. Some extend and stow manually while others are operated electrically.

**BACKFLOW CHECK VALVE** - A device designed to allow flow in only one direction.

**BLACK WATER** – Term associated with the sewage holding tank. The toilet drains directly into this tank.

**BLUE BOY** - Also known as a honey pot. Refers to a portable waste holding tank that has wheels on one end. These tanks often are manufactured out of blue plastic, hence the nickname.

**BOON DOCKING** - Also known as dry camping. Camping without electrical and water hookups.

**BREAKAWAY SWITCH** - An electrical switch on trailers designed to engage the breaks in case the trailer breaks away from the tow vehicle. The switch is connected by a cable to the tow vehicle. Breakaway is detected when the switch cable is pulled out during vehicle separation.

**BRAKE CONTROLLER** - A device (customer supplied) mounted under the dash of a towing vehicle to control the braking system of the RV. Most brake actuators are based on a time delay application; the longer the brakes are applied tighter the trailer brakes react

**BRITISH THERMAL UNIT (BTU)** - Measurement of heat that is the quantity required to raise the temperature of one pound of water 1°F. RV air-conditioners and furnaces are BTU-rated.

**CAMBER (WHEEL ALIGNMENT)** - The number of degrees each wheel is off of vertical. Looking from the front, tops of wheels farther apart than bottoms means "positive camber". As the load pushes the front end down, or the springs get weak, camber would go from positive to none to negative (bottoms of wheels farther apart than tops).

**CAMPER** – For purposes of this manual, this term refers to your fifth wheel RV.

**CAMPING** - An outdoor recreational activity involving the spending of one or more nights in a tent, primitive structure or RV at a campsite with the purpose of getting away from civilization and enjoying nature.

**CAMPSITE** - The term usually means an area where an individual or family might go camping.

**CARBON MONOXIDE** – A colorless, odorless and poisonous gas.

**CARGO WEIGHT** - The actual weight of all items added to the Curb Weight of the vehicle or trailer. This includes personal cargo, optional equipment, and tongue or king pin weight.

**CARGO CARRYING CAPACITY (CCC)** - Equal to GVWR minus each of the following: UVW, full fresh (potable) water weight (including water heater), full propane weight and SCWR.

**CITY WATER** – Term associated with the water supply you hook up to at the campsite. It is called city water because water is pulled from a central outside source (like a city) and not the fresh water tank.

**CONDENSATION** - A result of warm moisture laden air contacting the cold window glass. Keeping a roof vent open helps to reduce the humidity levels. Added roof vent covers help to prevent cold air from dropping down through the vent while still allowing moist air to escape. Using the roof vent fan when showering or the stove vent fan when cooking also helps prevent excess moisture buildup.



**CONVERTER** - A device that converts 120 volt A/C (alternating current) to 12 volt DC (direct current). The RV devices mostly run on 12 volt DC power that is supplied by the battery, which allows the RV to function independently. When "shore power" (an electrical supply) is available, the converter changes the voltage from 120 to 12 volt to supply the appliances and to recharge the battery.

**CURB WEIGHT** - The actual weight of a vehicle or trailer, including all standard equipment, full fuel tanks, full fresh water tanks, full propane bottles, and all other equipment fluids, but before taking on any persons or personal cargo.

**CURBSIDE** – This refers to the side of the camper that faces the curb when parked. Also referred to as the door side or DS.

**DC ELECTRICITY** – Direct current also known as auxiliary battery power. For purposes of this owner's manual, it refers to 12-volt DC (abbreviated 12 VDC).

**DEALER** – For purposes of this manual, this refers to the independent dealer authorized to sell and/or service your camper by Grand Design RV. This term will be used in this context unless specified otherwise.

**DINETTE** - Booth-like dining area. Table usually drops to convert unit into a bed at night.

**DISPENSING** - As applied to gasoline or diesel fuel systems, withdrawing fuel from applicable recreational vehicle fuel tank(s) to other motorized vehicles or approved containers by means of a hose and hose nozzle valve.

**DISTRUBTION** - As applied to gasoline or diesel fuel systems, the flow of fuel from the recreational vehicle fuel tank(s) to an onboard fuel-burning generator by means of a closed system of tubing or hoses.

**DRAIN TRAP** – This is the curve that is in all drains. Water is trapped in the curve and creates a barrier so tank odors cannot escape through the drain.

**DRY CAMPING** – Camping when there is no city water hookup or shore power (i.e., using only the water and power available in the camper and not from any other source).

**DRY WEIGHT** - The actual weight of a vehicle or trailer containing standard equipment without fuel, fluids, cargo, passengers, or optional equipment.

**DSI (Direct Spark Ignition)** - This term refers to the method of igniting the main burner on a propane fired appliance. The burner is lit with an electric spark and the flame is monitored by an electronic circuit board. This ignition system is used in refrigerators, furnaces and water heaters. There is now a version of stove tops that light the burners with a DSI ignition.

**DUAL ELECTRICAL SYSTEM** - RV equipped with lights, appliances which operate on 12-volt battery power when self-contained, and with a converter, on 110 AC current when in campgrounds or with an onboard generator

**DUALY** - A truck having two wheels on each side of the rear axle for a total of four wheels

**DUCTED A/C** - Air conditioning supplied through a ducting system in the ceiling. This supplies cooling air at various vents located throughout the RV.

**DUCTED HEAT** - Warm air from the furnace supplied to various locations in the RV through a ducting system located in the floor. (similar to house heating systems).

**DUMP STATION** – Site where you drain your gray water (waste) and your black water (sewage) tanks. In most states, it is illegal to drain your tanks anywhere except dump stations.

**DUMP VALVE** – Another name for the T-handle valve used to release and drain the black tank (sewage) and gray tank (waste).

**EGRESS WINDOW** – The formal name for the emergency escape window. Egress windows are identified by their labeling.

**FIFTH WHEEL (FW)** - A trailer and hitch configuration connected to the tow truck directly above the rear axle by way of a special fifth wheel hitch. This causes several feet of the connected trailer to hang over the tow truck, placing about 15 to 25% of the trailer's weight on the rear axle of the truck. Commercial trucks and trailers use this hitch configuration. Also commonly spelled as 5th wheel.

**FIVER** - Another name for a fifth wheel RV.

**FRESH WATER** – The fresh water system provides potable water to the fresh water tank, kitchen sink, shower, bathroom lavatory, toilet, water heater and outside shower.

**FRESH WATER TANK** - Tank for holding fresh water for drinking, cooking, and bathing while not connected to a city water supply.

**FUEL SYSTEM** - Any arrangement of pipe, tubing, fittings, connectors, tanks, controls, valves, and devices designed and intended to supply or control the flow of fuel.

**FULL HOOK-UP SITE** – A campsite that has city water, shore power and sewer hook-ups or connections available

**FULL TIMERS OR FULL TIMING** - The term used for people who live in their RV full time, or at least the vast majority of their time.

**GALLEY** - The kitchen in an RV.

**GENERATOR** - An engine powered device fuelled by gasoline or diesel fuel, and sometimes propane, for generating 120-volt AC power.

**GENSET** - Abbreviation for generator set.

**GOOSENECK** - A trailer and hitch configuration connected to the tow truck directly above the rear axle by way of a standard ball hitch in the truck bed and a vertical, slender arm on front of the trailer. Gooseneck hitching is common on horse and utility trailers, but rarely found on RV's.

**GRAY WATER** – Term associated with the waste water holding tank. Water from the sink drains, shower and washer/dryer (if so equipped) go into this tank.

**GROSS AXLE WEIGHT RATING (GAWR)** – The MAXIMUM ALLOWABLE WEIGHT each axle assembly is designed to carry, as measured at the tires, therefore including the weight of the axle assembly itself. GAWR is established by considering the rating of each of its components (tires, wheels, springs, axle), and rating the axle on its weakest link. The GAWR assumes that the LOAD IS EQUAL ON EACH SIDE.

**GROSS CARRYING CAPACITY (GCC)** - Means the maximum carrying capacity of your camper. The GCC is equal to the GVWR minus UVW. The GCC will be reduced by the weight of fresh water or other tanks, propane, occupants, personal items or dealer installed accessories.

**GROSS COMBINED WEIGHT RATING (GCWR)** - The MAXIMUM ALLOWABLE COMBINED WEIGHT of the tow vehicle and attached towed vehicle. GCWR assumes that both vehicles have functioning brakes, with exceptions in some cases for very light towed vehicles, normally less than 1,500 pounds. (Check your tow vehicle's towing guide.)

**GROSS TRAILER WEIGHT RATING (GTWR)** - The MAXIMUM TOWED VEHICLE WEIGHT. Each component (receiver, drawbar, ball) of a ball-type hitch has its own rating. Some ball-type hitches have separate ratings when used with a weight distributing system.

**GROSS VEHICLE WEIGHT RATING (GVWR)** – The MAXIMUM ALLOWABLE WEIGHT of the fully loaded vehicle, including liquids, passengers, cargo, and the tongue weight of any towed vehicle.

**HEAT EXCHANGER** - A device that transfers heat from one source to another. For example, there is a heat exchanger in your furnace - the propane flame and combustion products are contained inside the heat exchanger that is sealed from the inside area. Inside air is blown over the surface of the exchanger, where it is warmed and the blown through the ducting system for room heating. The combustion gases are vented to the outside air.

**HEAT STRIP** - A heat strip is an electric heating element located in the air conditioning system with the warm air distributed by the air conditioner fan and ducting system. They are typically 1500 watt elements (about the same wattage as an electric hair dryer) and have limited function. Basically they "take the chill off."

**HIGH PROFILE** - A fifth-wheel trailer with a higher-than-normal front to allow more than 6 feet of standing room inside the raised area.

**HITCH** - The fastening unit that joins a movable vehicle to the vehicle that pulls it.

**HITCH WEIGHT** – The amount of the camper's weight that rests on the tow vehicle. It should be approximately 12% - 15% with conventional trailers; approximately 18% -21% for fifth wheels.

**HOLDING TANKS** - There are three different holding tanks on most RVs; fresh water tank, gray water tank and black water tank. The fresh water tank holds fresh water that can be stored for later use. The gray water tank holds the waste water from the sinks and showers. The black water tank holds the waste from the toilet.

**HONEY WAGON** - Euphemism for the sewage pumping truck. Honey wagons are used to empty RV holding tanks in places where full hookups and dump stations are not available.

**HOOKUPS** - The ability of connecting to a campground's facilities. The major types of hookups are electrical, water and sewer. If all three of these hookups are available, it is termed full hookup. Hookups may also include telephone and cable TV in some campgrounds.

**HOUSE BATTERY** - One or more batteries in a RV for operating the 12 volt lights, appliances, and systems. House batteries can be 12 volt units tied in parallel or pairs of 6 volt batteries tied in series (to double the voltage). The term house battery is of more significance in motor homes because they contain one or more other batteries for the operation of the engine, referred to as the chassis or starting batteries.

**HULA SKIRT** - Term used for a type of dirt skirt accessory some RVers use on the back of their motorhome to aid in the protection from debris thrown from their rear wheels to the vehicles directly behind them or being towed behind them. This dirt skirt is usually the length of the rear bumper and resembles a 'short' version of a Hawaiian 'hula-skirt', hence the term.

**INVERTER** - An inverter is a device that changes 12 volt battery power to 120 volt AC power. It is used when "boon docking" (camping without hookups) to power certain 120 VAC only devices like a microwave oven. The amount of available power depends on the storage capacity of the batteries and the wattage rating of the inverter.

**IRON RANGER** - A fee collection box used at campgrounds that do not have full time attendants. Upon entrance to the campground, you deposit your nightly fee(s) in an envelope with your name and site number and drop this in the collection box. At some time during the day, a park ranger will make rounds of the campgrounds and collect the fees. You will often see these in National Park and National Forest campgrounds.

**ISLAND QUEEN OR ISLAND KING** - A king or queen-sized bed with walking space on both sides.

**JACKKNIFE** - 90° angle obtained from turning/backing fifth wheel or travel trailer with tow vehicle. Jackknifing a short bed truck towing a fifth wheel without the use of a slider hitch or extended fifth wheel pin box can result in damage to the truck cab or breaking out the back window of the truck cab from the truck and fifth wheel "colliding".

**KING PIN** - The pin by which a fifth wheel trailer attaches to the truck. It slides into the fifth wheel hitch and locks in place.

**KING PIN WEIGHT** - The actual weight pressing down on the fifth wheel hitch by the trailer. The recommended amount of King Pin Weight is 15%-25% of the GTW, also called Pin Weight.

**LAMINATE** - A sandwich of structural frame members, wall paneling, insulation and exterior covering, adhesive-bonded under pressure and/or heat to form the RV's walls, floor and/or roof.

**LANDING GEARS** - See Leveling Jack.

**LEVELING** - Positioning the RV in camp so it will be level, using ramps (also called levelers) placed under the wheels, built-in scissors jacks, or power leveling jacks.

**LEVELING JACK** - A jack lowered from the underside of trailers and motor homes for the purpose of leveling the vehicle. A leveling jack is designed to bear a significant portion of the RV's weight.

**LP GAS** - Liquefied Petroleum Gas, commonly written as "LP Gas". Two examples of LP Gas are propane and butane. LP Gas is heavier than air in gas form and about half the weight of water in liquid form. LP gas is used to fuel appliances in the RV, such as the stove, oven, water heater and refrigerator. Propane tanks are usually rated as pounds or gallons.

**LOW POINT** – The lowest point in the plumbing. Drains are placed here so that water will drain out of the lower end of the camper when flushing or winterizing the water system. These drains must be closed when you fill the water tank.

**MOTORHOME (MH)** - A motor vehicle built on a truck or bus chassis and designed to serve as self-contained living quarters for recreational travel.

**NET CARRYING CAPACITY (NCC)** - The MAXIMUM WEIGHT of all personal belongings, food, fresh water, propane, tools, dealer installed accessories, etc., that can be carried by the RV.

**NONPOTABLE WATER** - Water not suitable for human consumption.

**OEM** – This refers to the original equipment manufacturer of the individual appliance or component.

**OVERFILLING PREVENTION DEVICE (OPD)** - A safety device that is designed to provide an automatic means to prevent the filling of a container in excess of the maximum permitted filling limit.

**PARK MODEL** - A travel trailer that requires park facilities to function. It lacks holding tanks and dual-voltage appliances, requiring to be plugged into water, sewage, and electrical facilities. A park model is more of a small mobile home than a recreational vehicle, in appearance and function.

**PART TIMERS** - The term used for people who use their RV more than usual (more than just a few weekend trips a year), but who still use it less than full time.

**PATIO MAT** - Carpet or woven mat for use on ground outside of RV. Used whether or not a concrete patio pad is available where camping.

**PAYLOAD CAPACITY** - The maximum allowable weight that can be placed in or on a vehicle, including cargo, passengers, fluids and fifth-wheel or conventional hitch loads.

**PILOT** - A pilot is a small standby flame that is used to light the main burner of a propane fired appliance when the thermostat calls for heat. Pilots can be used in furnaces, water heaters, refrigerators, ovens and stove tops.

**PLUMBING VENT** - Any pipe provided to ventilate a plumbing system, to prevent trap siphonage and back pressure, or to equalize the air pressure within the drainage system.

**PORPOISING** - A term used to define the up and down motion in an RV while traveling

**POWER SOURCE** – Also referred to as shore power, this refers to the receptacle outlet you are using to plug in your shoreline power cord. This can be a campsite power box or electrical box, a residential receptacle outlet specifically wired for your camper or a generator (customer supplied).

**PRIMITIVE SITE** – A campsite that may have city water, shore power or sewer hook-ups but not all of them; primitive sites may have no hook-ups or connections at all.

**PROPANE** - LPG, or liquefied petroleum gas, used in RVs for heating, cooking and refrigeration. Also called bottle gas, for manner in which it is sold and stored. This is the proper term in the RV industry when referring to "LP Gas."

**PULL-THROUGH SITES** – Campsites you can drive through and park (without having to back up into the site).

**REFER** - Slang for "refrigerator". Refrigerators are often found in either a "two-way" or "three-way" operating mode. Two-way: has a gas mode and an AC mode. Three-way: has a gas mode, AC mode, and 12v DC mode. The coolant used in RV refrigeration is ammonia. The two most common manufacturers of RV refrigerators are Norcold and Dometic.

**RIG** - What many RVers call their units.

**ROADSIDE** – This refers to the side of the camper that faces the road when it is parked. Often called the off-door side.

**ROOF AIR CONDITIONING** - Air conditioning unit mounted on roof of RV, to cool the RV when it is parked. When moving, most RVs are cooled by separate air conditioning units which are components of the engine, or they may be cooled by a roof top if a proper size generator is installed.

**RV** - Short for Recreational Vehicle, a generic term for all pleasure vehicles which contain living accommodations. Multiple units are RVs and persons using them are RVers.

**RVDA** - Abbreviation for Recreational Vehicle Dealer's Association.

**RVIA** - Abbreviation for Recreational Vehicle Industry Association

**SELF CONTAINED** - RV which needs no external electrical, drain or water hookup. Thus, it can park overnight anywhere. Of course, self-contained units can also hook up to facilities when at campgrounds.

**SANITIZATION** – Refers to the camper's fresh water system that has been sanitized with chlorine bleach before use or after storage.

**SHORELINE POWER CORD** – This is the electrical power cord that runs from the camper to the campsite shore power outlet.

**SLEEPING CAPACITY WEIGHT RATING (SCWR)** – The manufacturer's designated number of sleeping positions multiplied by 154 pounds (70 kilograms).

**SLIDEOUT** - A compartment added to an RV to increase interior space. It slides into the body during travel and slides out when parked.

**SNOWBIRD** - Term for someone in a northern climate that heads "south" in winter months.



**STINKY SLINKY** - Slang for the sewer hose, constructed from a spiral wire covered with vinyl. One end attaches to the RV piping and the other into the local sewer dump facilities

**STREETSIDE** - The part of the vehicle on the street side when parked. (Also referred to as the off door-side or ODS.)

**SURGE PROTECTOR** – Device (customer supplied) that is installed at the power supply location designed to prevent “surges” or “spikes” in electrical current that may damage the RV’s electrical/electronic components.

**SWAY** - Fishtailing action of the trailer caused by external forces that set the trailer's mass into a lateral (side-to-side) motion. The trailer's wheels serve as the axis or pivot point. Also known as "yaw."

**THERMOCOUPLE** - A thermocouple is a device that monitors the pilot flame of a pilot model propane appliance. If the pilot flame is extinguished the thermocouple causes the gas valve to shut off the flow of gas to both the pilot flame and the main burner.

**TIP OUT** - The term used for an area or room in an RV that tips out for additional living space. The Tip-Out was generally used in older RVs. Newer RVs mainly use a slide-out.

**TIRE RATINGS** - The MAXIMUM LOAD that a tire may carry is engraved on the sidewall, along with a corresponding COLD inflation pressure. A reduction in inflation pressure requires a reduction in load rating. Tire manufacturers publish charts that establish the load capacity at various inflation pressures.

**TOE (WHEEL ALIGNMENT)** - Toe is the measure of whether the front of the wheels (looking down from the top) are closer (toe-in) or farther (toe-out) than the back of the wheels.

**TONGUE WEIGHT, TONGUE LOAD, VERTICAL LOAD (TWR/TLR/VLR)** - Tongue Weight, Tongue Load, Vertical Load Rating Different terms for the MAXIMUM VERTICAL LOAD that can be carried by the hitch UNLOADED.

**TRAILER BRAKES** - Brakes that are built into the trailer axle systems and are activated either by electric impulse or by a surge mechanism. The overwhelming majority of RVs utilize electric trailer brakes that are actuated when the tow vehicle's brakes are operated, or when a brake controller is manually activated. Surge brakes utilize a mechanism that is positioned at the coupler, that detects when the tow vehicle is slowing or stopping, and activates the trailer brakes via a hydraulic system (typically used on boats).

**TRAVEL TRAILER (TT)** - Also referred to as "conventional trailers," these types of rigs have an A-frame and coupler and are attached to a ball mount on the tow vehicle. Travel trailers are available with one, two or three axles. Depending upon tow ratings, conventional trailers can be towed by trucks, cars or sport-utility vehicles.

**UMBILICAL CORD** - Wiring harness which connects the trailer to the tow vehicle during transport. The umbilical cord supplies the trailer with DC power for charging the batteries and operating DC equipment. It also operates the trailer brakes and signal lights. (Also referred to as the 7-way power cord.)

**UNDERBELLY** - The RV's under-floor surface, which is protected by a weatherproofed material.

**UTQGL (UNIFORM TIRE QUALITY GRADE LABELING)** - A program that is directed by the government to provide consumers with information about three characteristics of the tire: tread wear, traction and temperature. Following government prescribed test procedures, tire manufacturers perform their own evaluations for these characteristics. Each manufacturer then labels the tire, according to grade.

**UV DEGRADATION** - A breaking down of material due to the sun's harsh ultraviolet rays.

**UNLOADED VEHICLE WEIGHT (UVW)** -The WEIGHT of a vehicle as built at the factory with full fuel, engine (generator) oil and coolants. It does not include cargo, fresh water, propane, occupants, or dealer installed accessories.

**WALLY WORLD** - Slang term used by RVers to describe a Wal-Mart.

**WASTE WATER TANKS** - The gray water tank holds the waste water from the sinks and showers. The black water tank holds the waste from the toilet.

**WATER PRESSURE REGULATOR** - Device (customer supplied) installed on the water hose attached to city water to limit the water pressure entering the RV. Most regulators limit water pressure to 40 psi.

**WEEKENDERS** - People who own their RV's for weekend and vacation use.

**WEIGHT & LOAD** - These terms are generally used interchangeably. For the purposes of understanding RV applications, vehicles have WEIGHT, which impart LOADS to tires, axles and hitches. Scale measurements taken when

weighing are LOADS carried by the tires. These measured loads are used to calculate Gross Vehicle Weight (GVW), Gross Axle Weight (GAW), Gross Combination Weight (GCW), and hitch loads.

**WET VENT** - A vent that also serves as a drain for one or more fixtures.

**WET WEIGHT** - The weight of the vehicle with the fuel, freshwater and propane tanks full. Note:

- Propane weighs 4.25 pounds per gallon
- Water weighs 8.3 pounds per gallon
- Gasoline weighs 6.3 pounds per gallon
- Diesel fuel weighs 6.6 pounds per gallon

**WIDE BODY** - An RV having an external body width greater than 96 inches (8 feet). The most common wide-body widths are 100" and 102."

**WINTERIZED** – Refers to a camper that has been prepared for storage. The water systems have been drained and RV antifreeze has been added to protect the water lines and drains. The low point drains should be in the open position.

**WORK CAMPER** - A person living in an RV and working. Many spell it as "workamper" after the web site and service by that name.

**YAW** - Fishtailing action of the trailer caused by external forces that set the trailer's mass into a lateral (side-to-side) motion. The trailer's wheels serve as the axis or pivot point. Also known as "sway."

This page is intentionally blank

**Index**

120-volt AC circuit breakers .....	67	Cooking with propane .....	90, 115
120-volt AC system .....	67	Countertops .....	135
12-volt DC outlet .....	75	Dealer's responsibilities .....	7
12-volt DC system .....	73	Décor items .....	134
12-volt fuse panel .....	74	Drain pipes with dry sealing valves .....	105
7-way wire harness/connector plug .....	58	Drain pipes with p-traps .....	104
About this manual .....	1	Ducting and return air .....	119
ABS plastic .....	136	DVD operation .....	123
Address, mailing .....	1	Effects of prolonged occupancy .....	37
Address, shipping .....	1	Electrical load ratings, approximate .....	79
Air conditioner .....	120	Emergency egress window .....	26
Alarm, combo carbon monoxide/ propane .....	30	Emergency stopping .....	54
Alarm, propane .....	85	Emergency towing .....	55
An important note about alterations and warranties .....	9	Emergency weather planning .....	25
Appliances .....	115	Exhaust gas fumes .....	83
Awning, patio .....	121	Faucets .....	100
Awning, rear .....	130, 132	Fire extinguisher .....	27
Awning, slideout .....	121	Fire safety .....	27
Battery disconnect switch .....	73	Fireplace .....	121
Battery isolator .....	58	Flooring .....	135
Battery, auxiliary .....	73	Formaldehyde .....	36
Battery, Tow vehicle .....	58	Frame, trailer .....	139
Black/grey water holding tanks .....	105	Fresh water connections .....	94
Black/grey water system .....	104	Fresh water system .....	93
Black/grey water tanks, emptying .....	105	Fresh water system, draining .....	101
Brake controller .....	58	Fresh water tank, filling .....	94
Breakaway switch .....	59	Fuel station .....	81
Bumper, rear .....	140	Furnace .....	121
Cabinetry and tables .....	134	Furniture upholstery .....	133
Cable/satellite outlet .....	125	Garage .....	127
Cable/satellite, diagram .....	126	Generator prep .....	78
Calculating electrical load .....	70	Generator .....	75
Calculating propane usage .....	90	GFCI receptacle .....	69
Carbon monoxide .....	29	Glossary .....	153
Cargo capacities .....	45	Grease Fire .....	115
Carpet .....	135	Heat pump .....	120
CD operation .....	123	Heating and cooling .....	119
Central vacuum .....	117	Hitching procedures .....	60
Chairs, freestanding .....	133	Indoor air quality .....	34
Chemical sensitivity .....	36	Ladder, roof .....	140
Cleaning, exterior .....	137	Leveling your RV .....	62
Cleaning, interior .....	133	Light bulbs .....	78
Cold weather usage .....	39	Loading your RV .....	46
Component manufacturer list .....	23	Lug nut torque .....	54
Condensation .....	37	Maintenance schedule .....	143
Converter .....	69	Maintenance, electrical systems .....	67
		Manufacturing certification .....	2
		Microwave .....	115
		Mini-EMS .....	70

## Glossary & Index

Monitor panel.....	93	Smoke alarm.....	28
Obtaining emergency warranty repair ...	8	Stereo operation .....	123
Obtaining emergency warranty repair, weekends.....	9	Storage, RV .....	141
Obtaining warranty service .....	8	Table, freestanding .....	133
Occupant safety.....	25	Thermostat .....	119
Outside shower .....	99	Tire identification number (TIN) .....	52
Owner's information package .....	1	Tire labeling.....	51
Owner's responsibilities .....	7	Tire maintenance, basic .....	48
Paneling .....	134	Tire ply.....	52
Pantry .....	134	Tire pressure and load limits.....	48
Parking.....	120	Tire safety information.....	47
Patio deck .....	129, 131	Tire safety tips.....	50
Pin box.....	59	Tire size and type designation.....	51
Power bed with side and sleep sofa .....	128	Tire size .....	51
Power cord, 50 amp .....	68	Tire tread.....	50
Pre-travel information.....	43	Tire, Spare .....	53
Propane gas container.....	86	Tires, effects of overloading.....	53
Propane gas .....	85	Toilet .....	106
Propane leak test.....	85	Tow vehicle disclaimer .....	43
Propane regulator .....	89	Towing and leveling .....	57
Propane system hoses, tubes, pipes & fittings .....	89	Towing.....	60
Ramp door .....	129	Traveling with propane .....	91
Range top with oven.....	116	Troubleshooting, basic.....	145
Rating, maximum load.....	52	TV operation.....	123
Rating, speed .....	52	TV reception, basics .....	123
Recliner sofa or loveseat .....	133	TV roof antenna .....	124
Refrigerator .....	115	TV signal booster.....	124
Replacement parts .....	10	Updating your contact information .....	10
Reporting safety defects, Canada.....	5	Using the propane system .....	90
Reporting safety defects, US .....	5	Utility center .....	94
Roof vent .....	119	Vehicle labels.....	43
Roof vents.....	139	Vents and vent pipes.....	105
RV braking system .....	58	VIN.....	2
RV driving schools and seminars .....	58	Warranty, One Year Limited Base .....	11
Safety precautions.....	3	Warranty, Three Year Limited Structural	17
Safety precautions, additional.....	41	Washer/dryer prep.....	116
Sanitization .....	101	Washing.....	137
Screen wall .....	130	Water filter.....	99
Sealant .....	140	Water heater .....	97
Setup.....	62	Water pressure regulator.....	96
Sewer tank flusher.....	106	Water pump .....	97
Shower walls.....	136	Waxing` .....	138
Sidewall vents.....	139	Website usage disclaimers .....	40
Sink and shower fixtures .....	136	Websites of interest .....	39
Sit and sleep sofa.....	129	Weighing your tow vehicle and RV .....	46
Slideout system, hydraulic.....	112	Weight labels.....	44
Slideout system, Schwintek.....	110	Weight ratings and definitions.....	44
Slideout systems.....	109	Windows .....	139
		Winterization.....	103





11333 County Road 2  
Middlebury, IN 46540  
(574) 825-8000  
[www.granddesignrv.com](http://www.granddesignrv.com)